

DESCRIPTION AND MATERIAL	<ul style="list-style-type: none">• Molded neoprene, some types available in polyurethane.• Two to twelve contacts, 12 AWG. (LPIL/LPBH-12 has 16 AWG. contacts.)• Up to 750 VDC.• Up to 10,000 PSI.• Bulkhead connector design open face pressure rated to 5,000 PSI.• Contacts gold plated per MIL-G-45204.
CABLE	<ul style="list-style-type: none">• Connectors in this series are molded on a standard 24" length of 16 AWG SO cable. IL-5, IL-12, LPIL-5 are molded on a standard 24" length of 18 AWG SO cable. LPIL-12 is molded on a standard 24" length of 20 AWG cable.• Custom lengths and cable types are available on request.• Bulkhead connectors have 12" teflon leads, Type E per MIL 16878/4 18 AWG.
USES	<ul style="list-style-type: none">• Light to heavy duty applications.• Hazardous environments.
GUIDELINES	<ul style="list-style-type: none">• All mounting surfaces require a 32 finish.• Lubricate mating surfaces with 3M Silicone Spray or equivalent, DO NOT grease! Connectors must be lubricated on a regular basis.• Lubricate o-rings with Dow Corning #111 Valve Lubricant or equivalent.• Align index pin prior to mating.• Avoid nicks and cuts around contacts as these are the sealing surfaces.• Elastomers can be seriously degraded if exposed to direct sunlight or high ozone levels for extended periods of time.• Do not over tighten bulkhead nuts.• Do not pull on cable to disconnect.• Avoid sharp bends at cable entry to connector.
ORDERING INFORMATION	<ul style="list-style-type: none">• Locking sleeves are optional, specify when ordering.• Bulkhead connectors do not come with nuts and washers. If required, please specify when ordering.• OM connectors do not come with overmolding boots. If required, please specify when ordering.
NOTE	<ul style="list-style-type: none">• For Mini Low Profile see Technical Bulletin 65 80• For Micro Mini Profile see Technical Bulletin 65 109

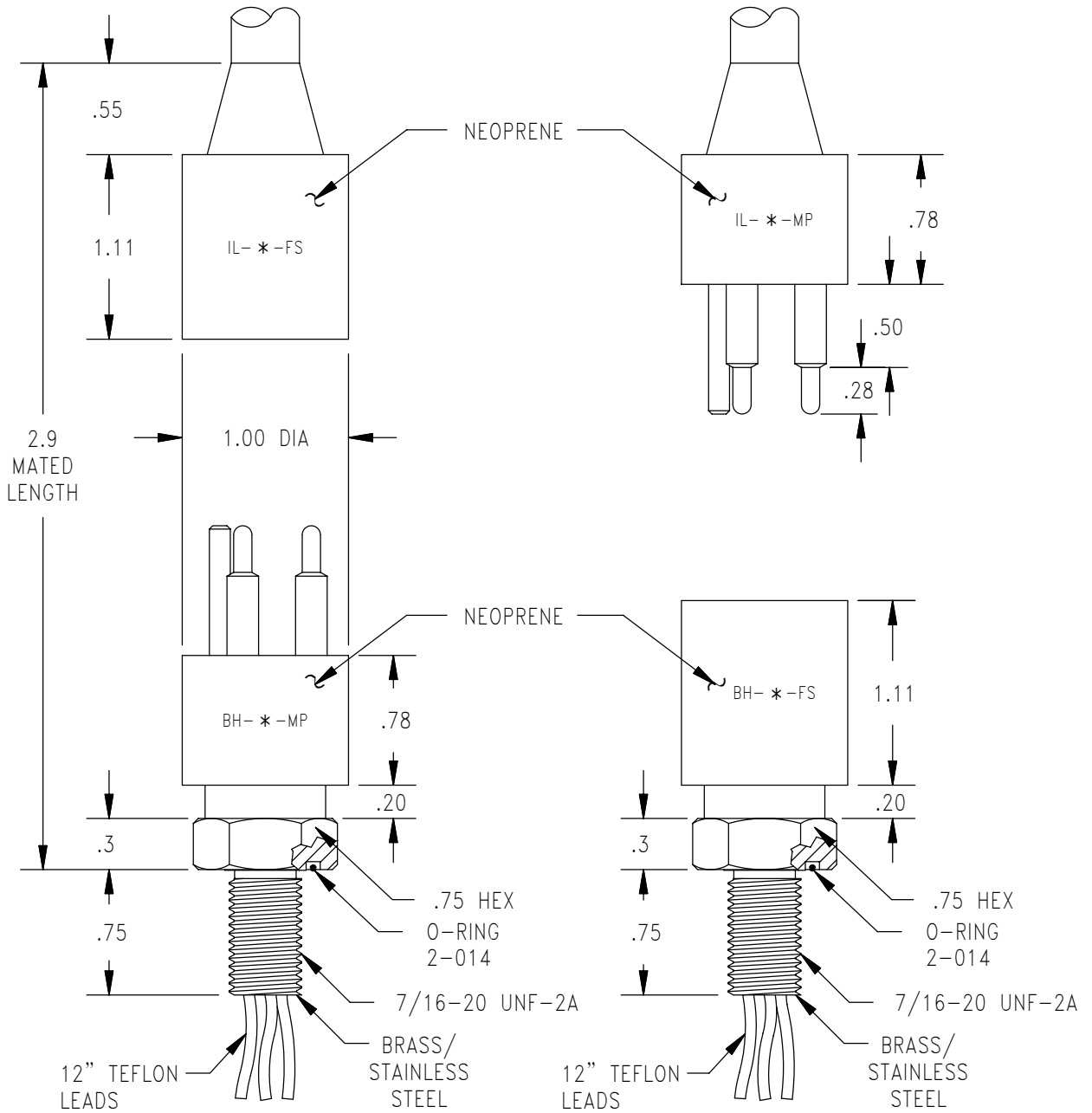

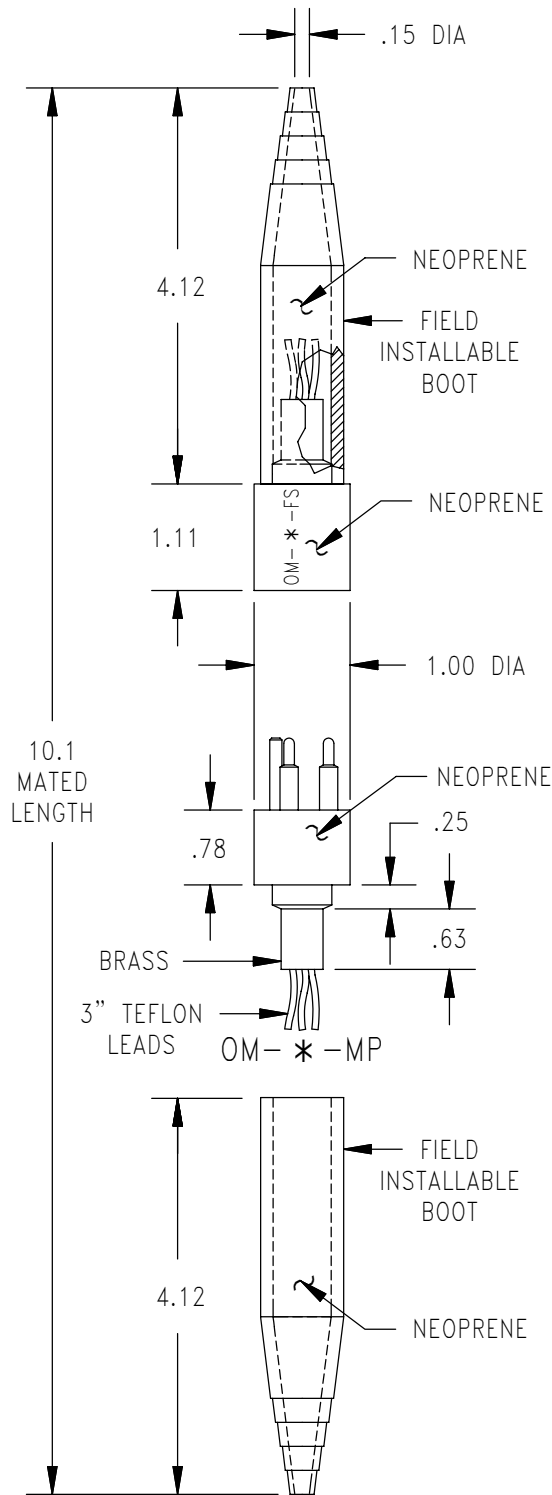

CONTACT
CONFIGURATION
(MP FACE VIEWS)

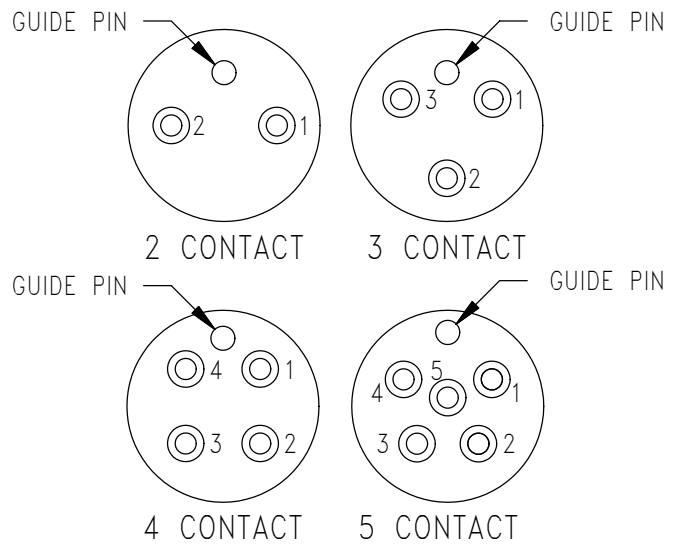

MOUNTING TORQUE FOR BH-FS/MP	not to exceed 100 in lbs
MATED PRESSURE RATING (psi)	10,000
DUMMY PLUG FOR BH-FS, IL-FS, OM-FS	DC- * -MP
DUMMY PLUG FOR BH-MP, IL-MP, OM-MP	DC- * -FS
NOTE: Delrin locking sleeves available (DLSA-M or F).	
* Specify number of contacts.	
* Dummy Plugs found on page 65 32.	

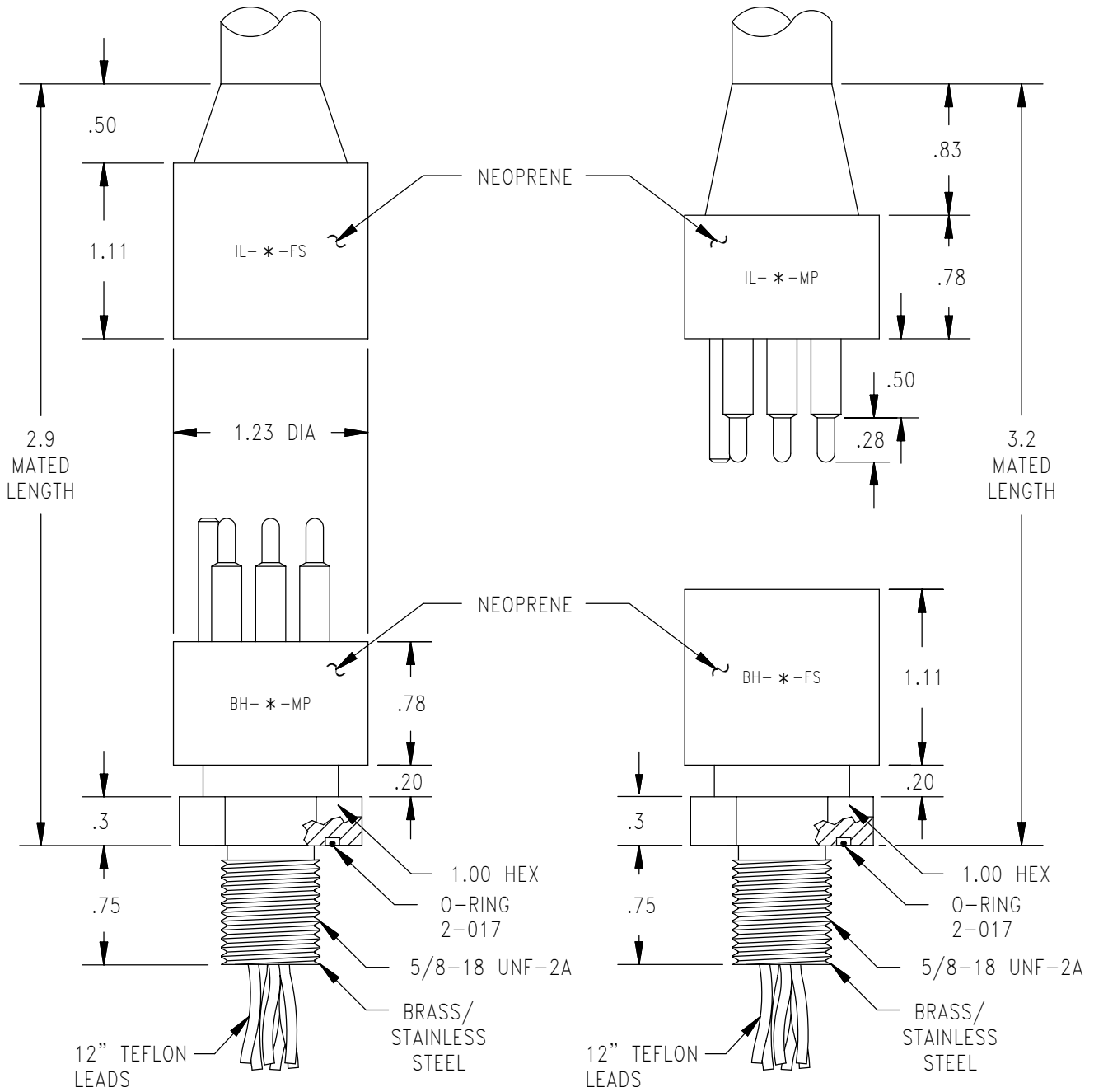

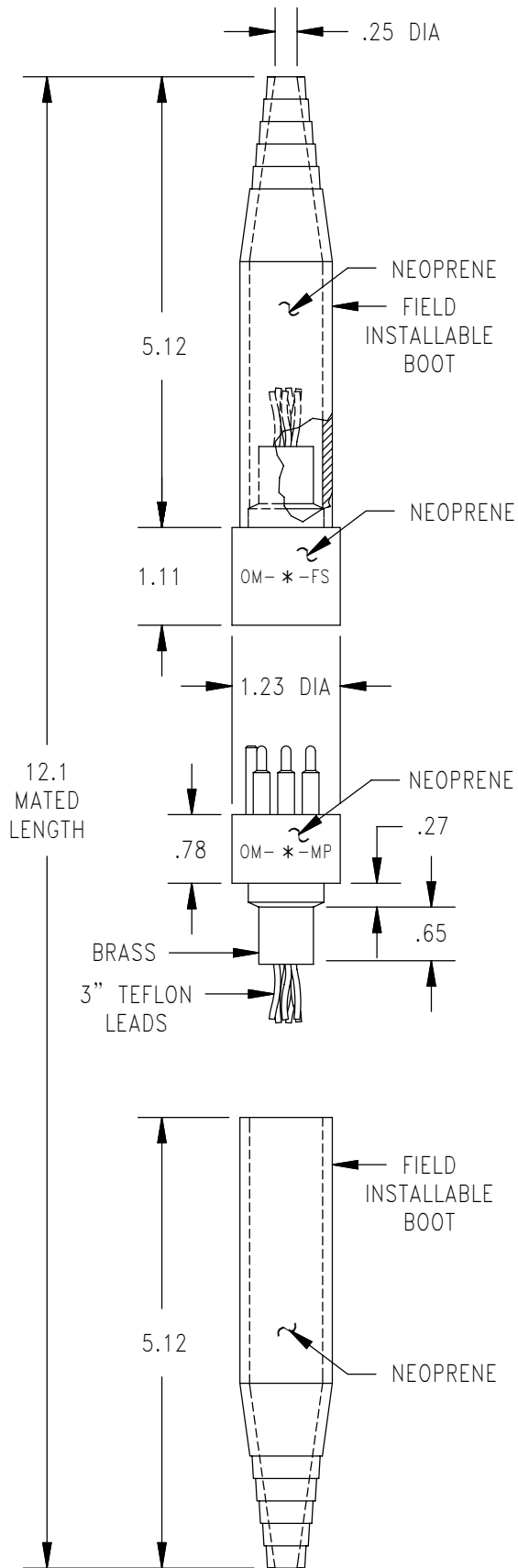

CONTACT
CONFIGURATION
(MP FACE VIEWS)

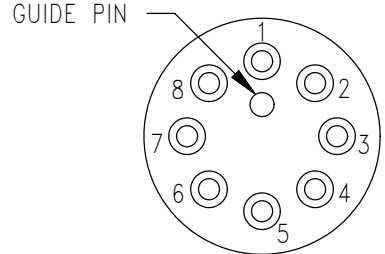
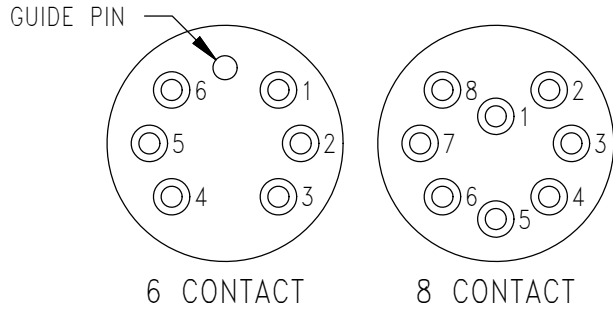

8 CONTACT
W/ GUIDE PIN (WH)

MOUNTING TORQUE FOR BH-FS/MP	not to exceed 100 in lbs
MATED PRESSURE RATING (psi)	10,000
DUMMY PLUG FOR BH-FS, IL-FS, OM-FS	DC- *-MP
DUMMY PLUG FOR BH-MP, IL-MP, OM-MP	DC- *-FS
NOTE: Delrin locking sleeves available (DLSB-M or F).	
* Specify number of contacts.	
* Dummy Plugs found on page 65 32.	

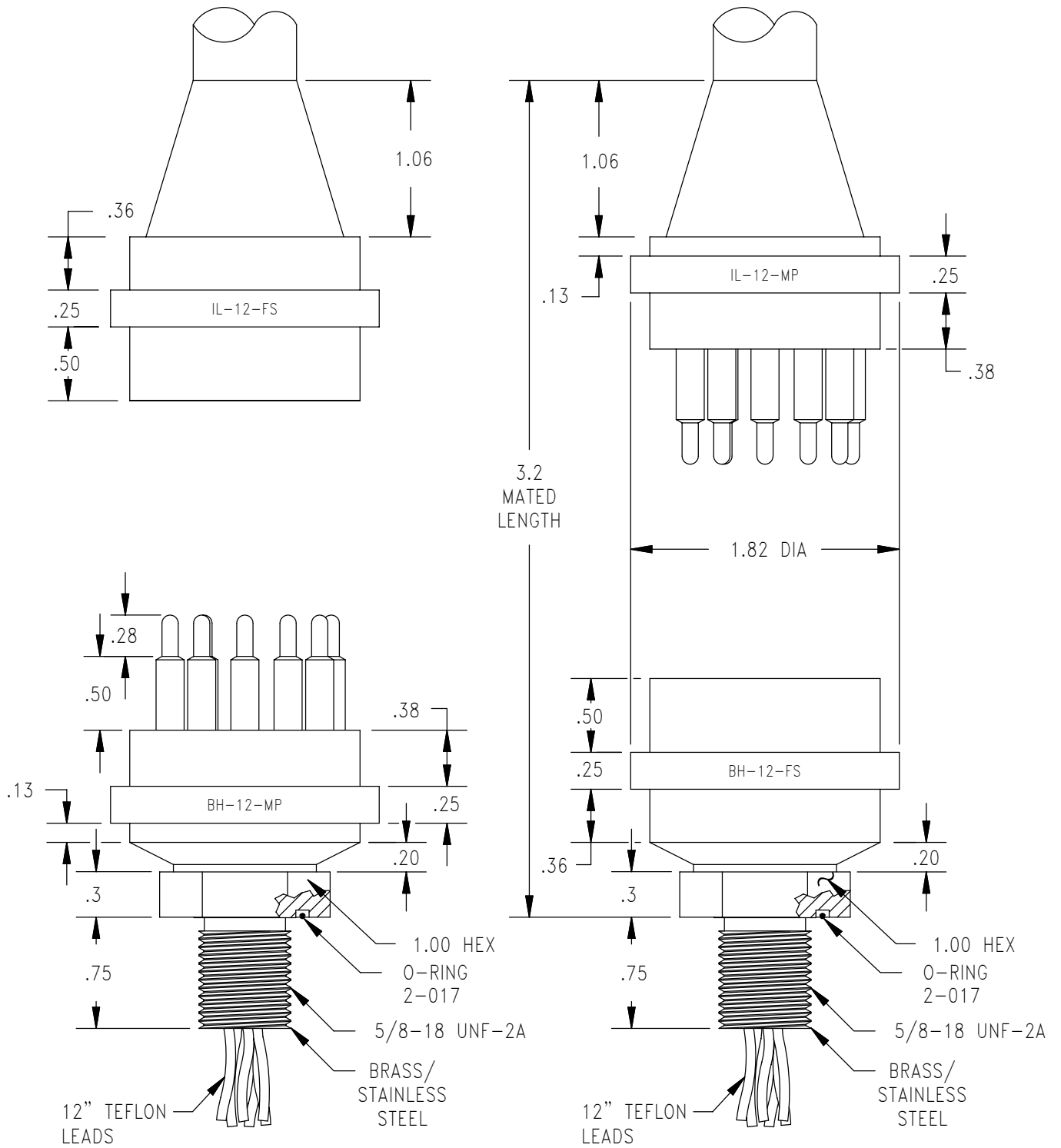

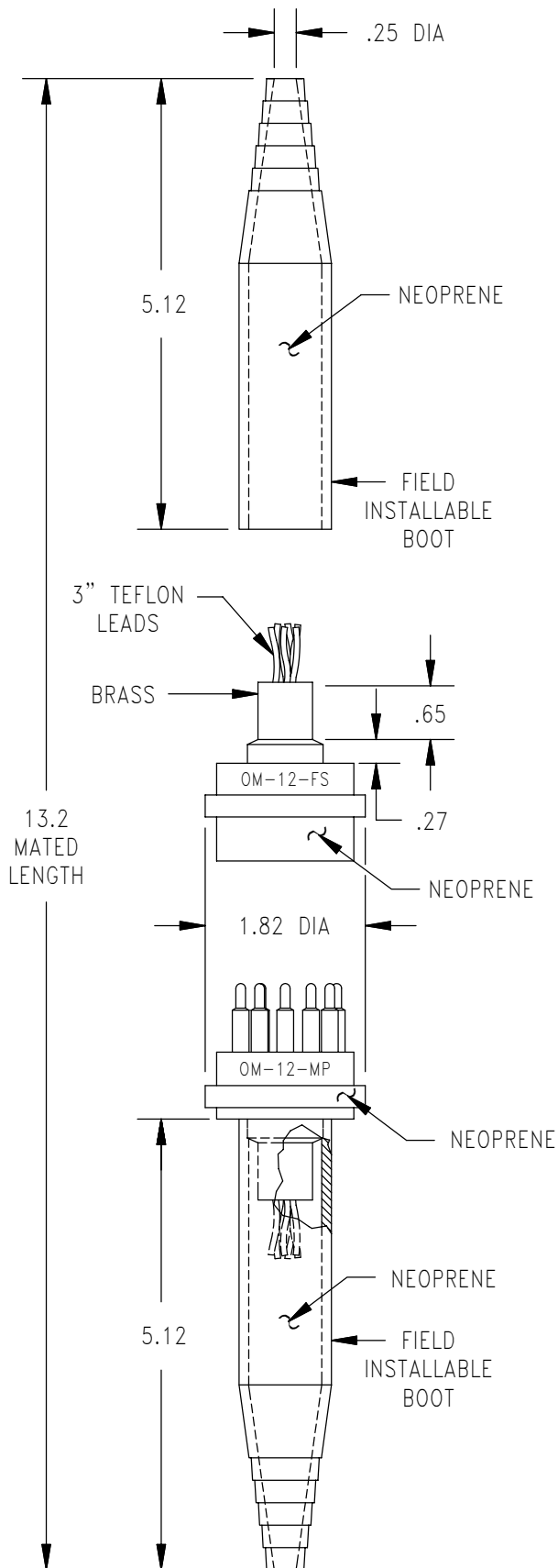

CONTACT
CONFIGURATION
(MP FACE VIEW)

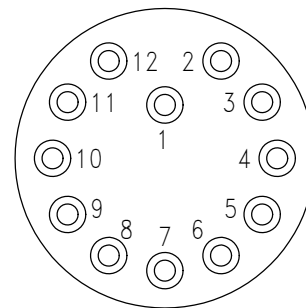

12 CONTACT

MOUNTING TORQUE FOR BH-FS/MP	not to exceed 100 in lbs
MATED PRESSURE RATING (psi)	10,000
DUMMY PLUG FOR BH-FS, IL-FS, OM-FS	DC-12-MP
DUMMY PLUG FOR BH-MP, IL-MP, OM-MP	DC-12-FS
NOTE: Delrin locking sleeve available (DLSC-M or F). * Dummy Plugs found on page 65 33.	

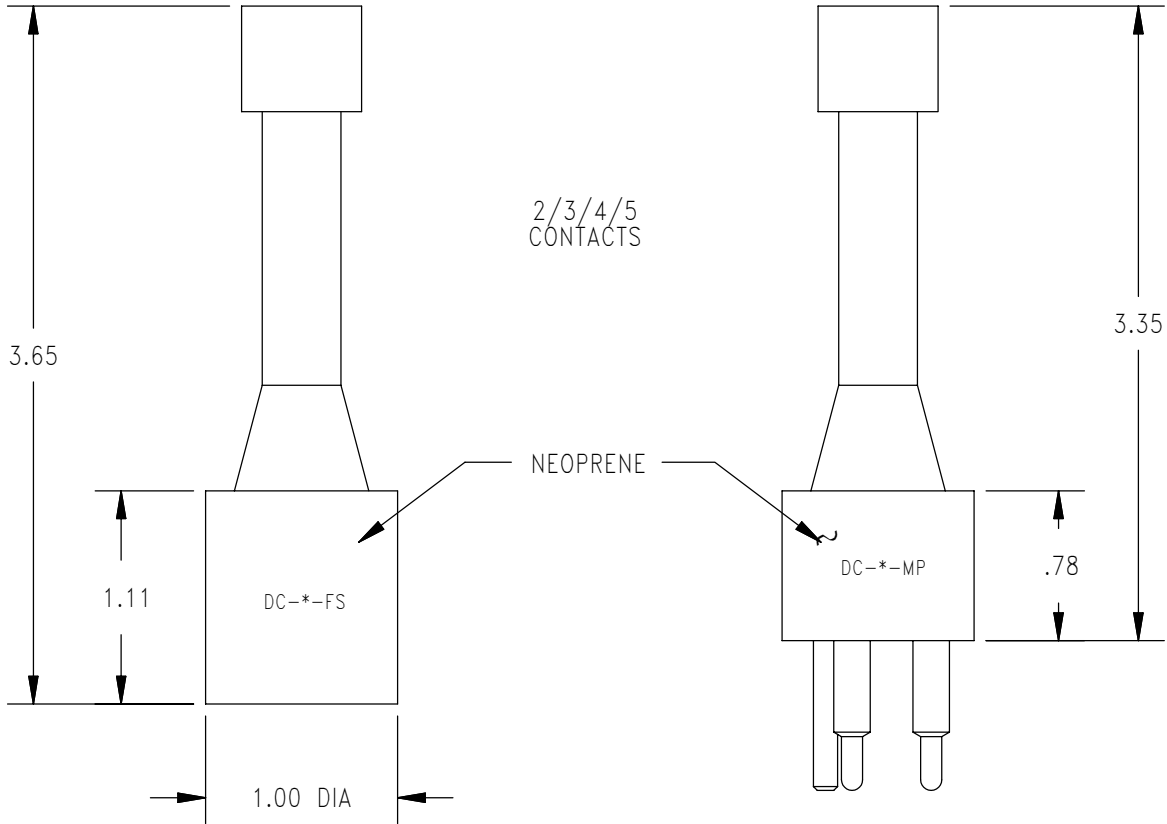

*SPECIFY NUMBER OF CONTACTS

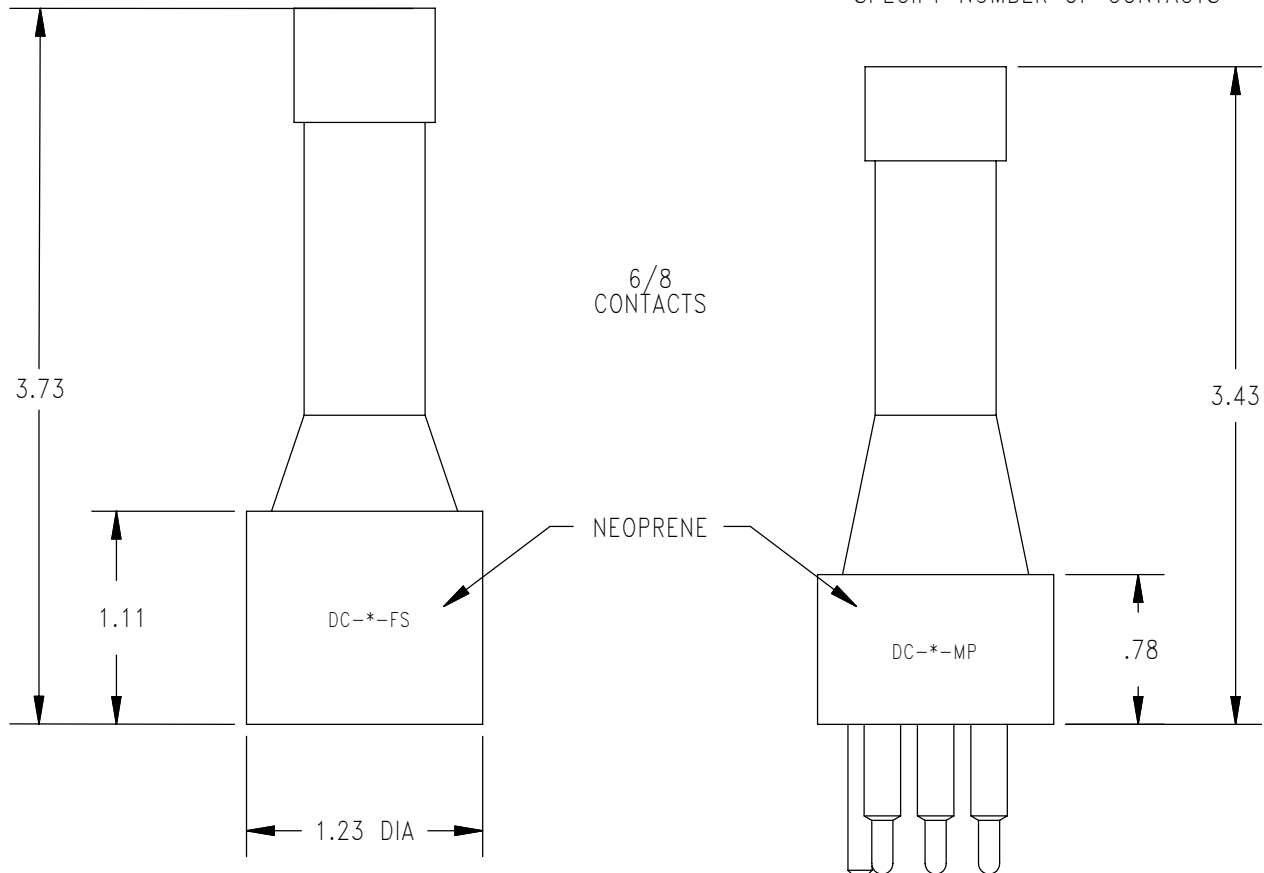

DC-12

WET
PLUGGABLE

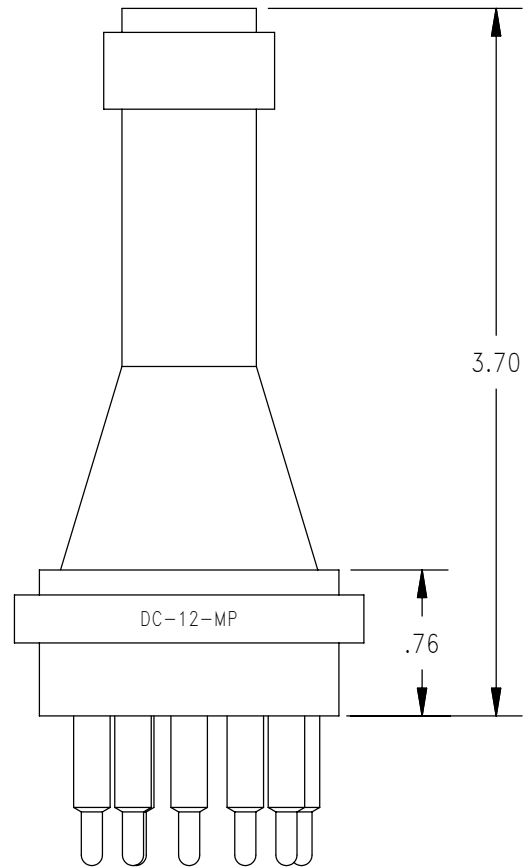
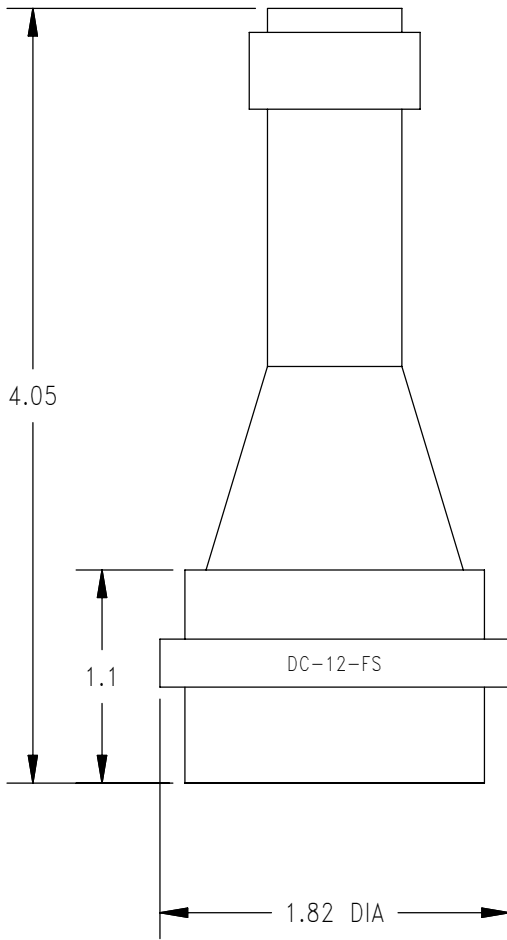

DELTRIN LOCKING SLEEVES

MALE

FEMALE

2,3,4,5,7,9 contact

DLSA-M

DLSA-F

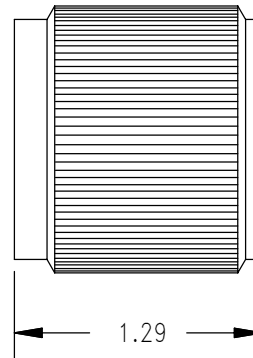
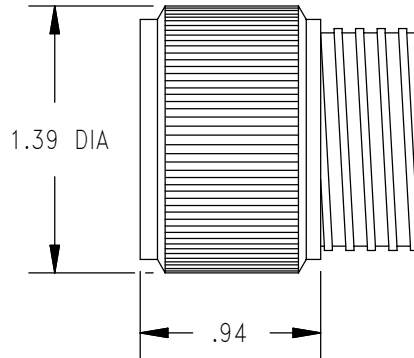

6,8, M12, 16,
HD 2/4 contact

DLSB-M

DLSB-F

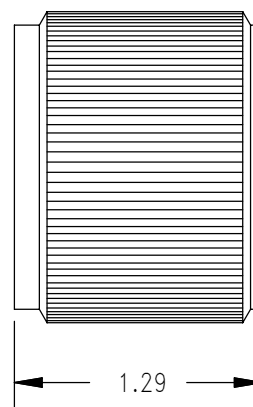
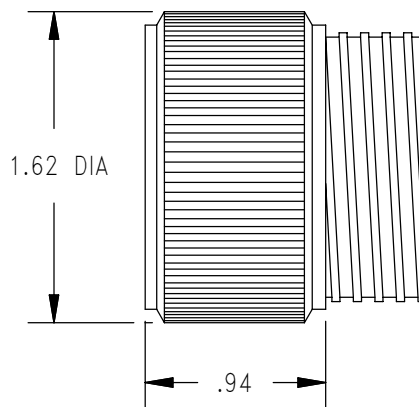

12 contact

DLSC-M

DLSC-F

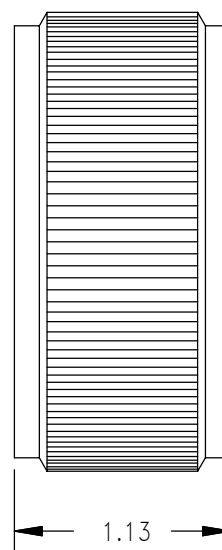
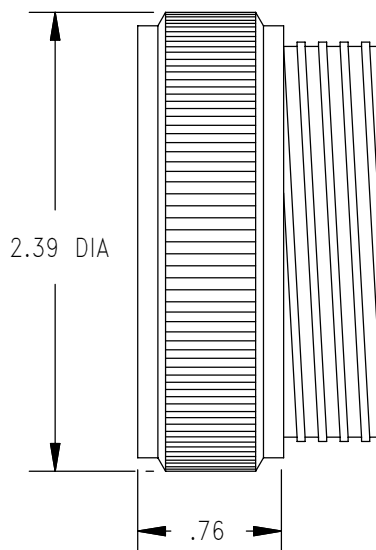

THIS PAGE INTENTIONALLY LEFT BLANK

CONTACT
CONFIGURATION
(MP FACE VIEWS)

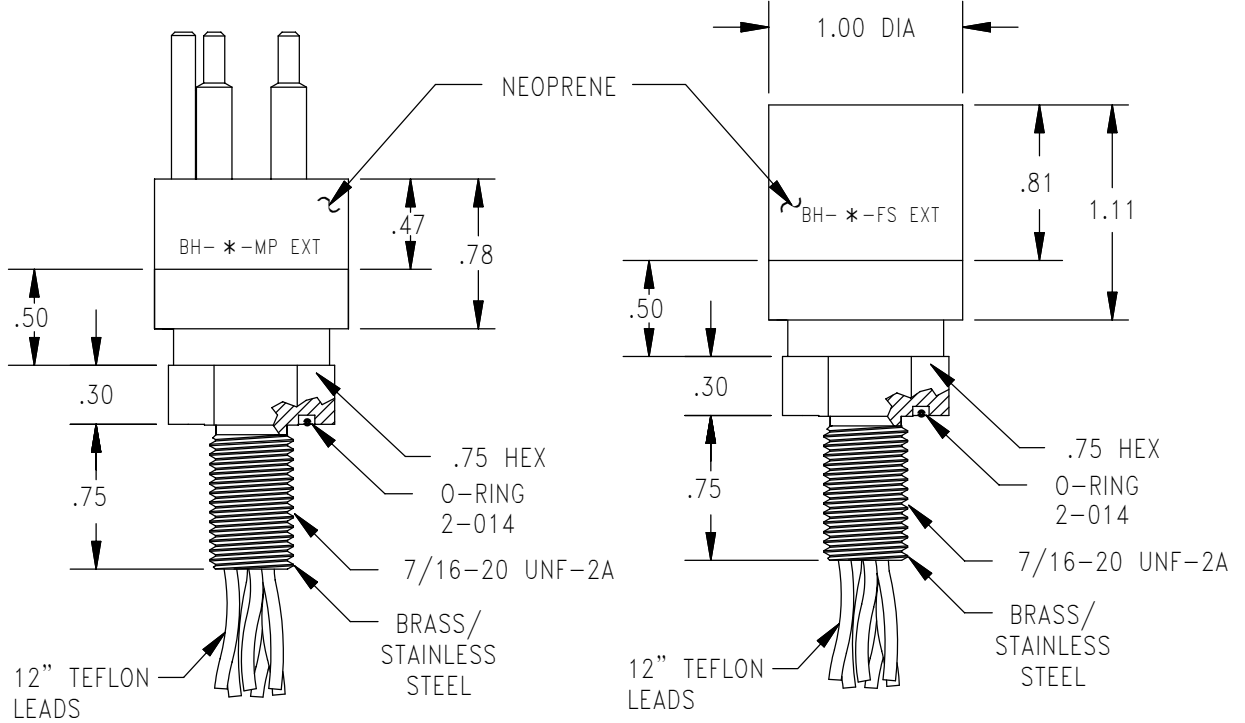
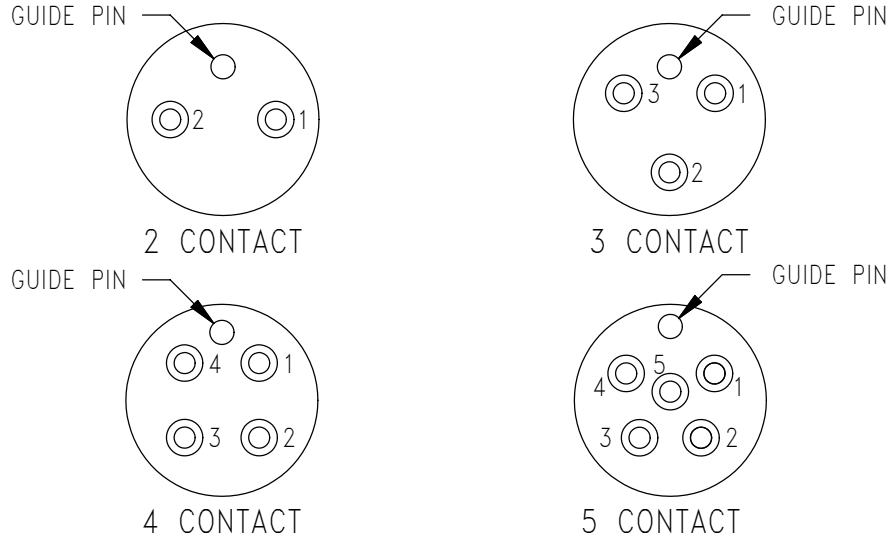

NOTE: For mating connectors see page 65 10
 For dummy connectors see page 65 32
 Delrin locking sleeves available (DLSA-M or F) see Page 65 35

CONTACT
CONFIGURATION
(MP FACE VIEWS)

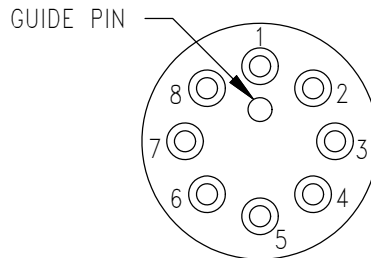
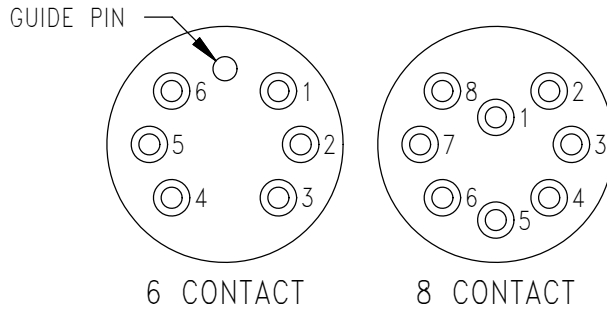

8 CONTACT
W/ GUIDE PIN (WH)

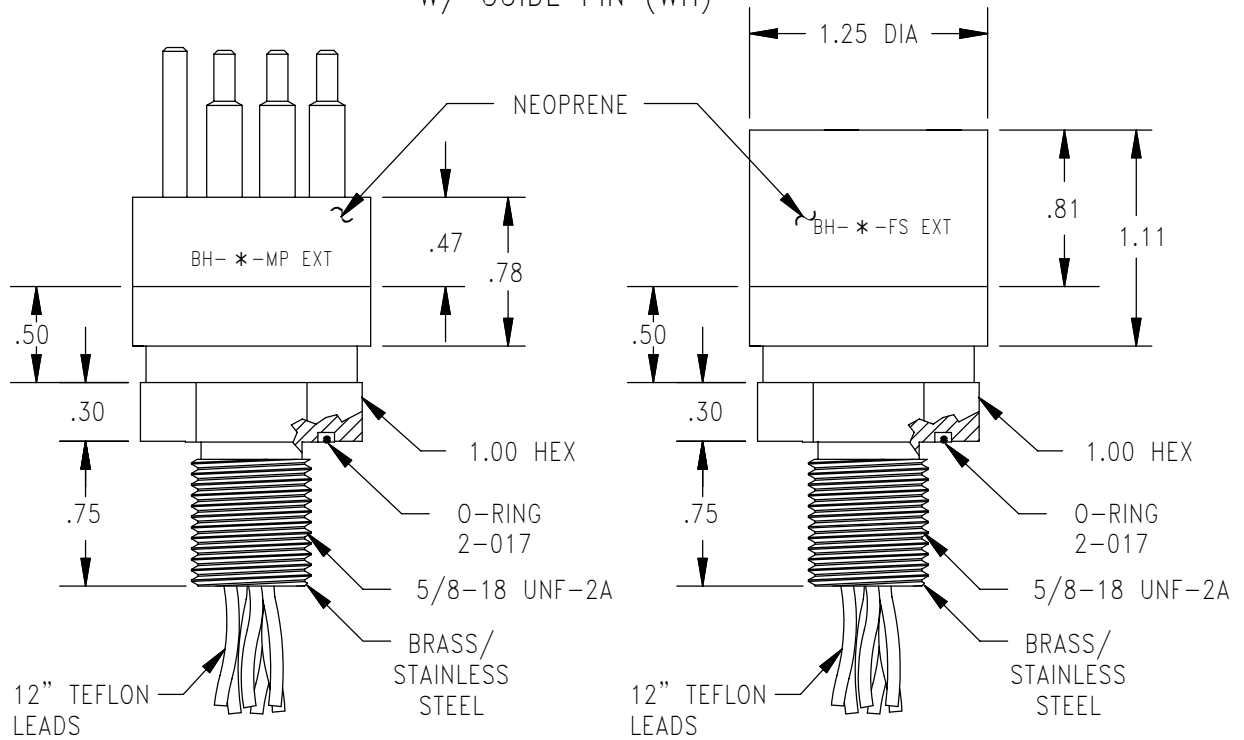

NOTE: For mating connectors see page 65 20
 For dummy connectors see page 65 32
 Delrin locking sleeves available (DLSB-M or F) see Page 65 35

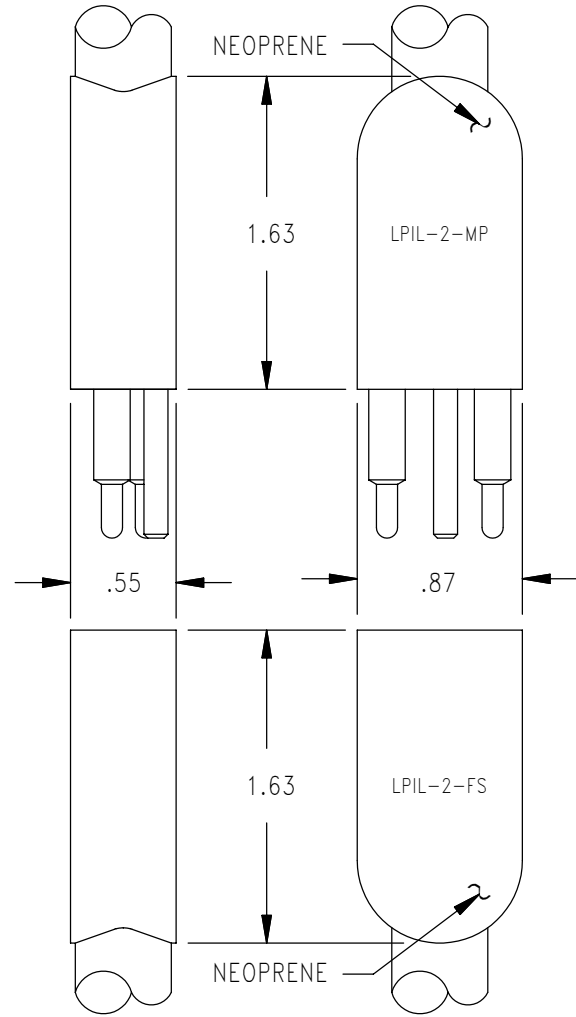
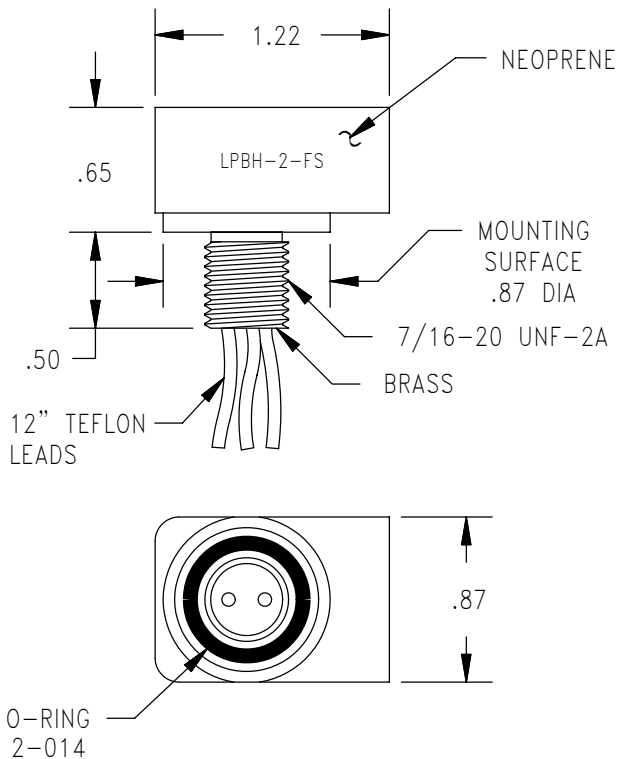
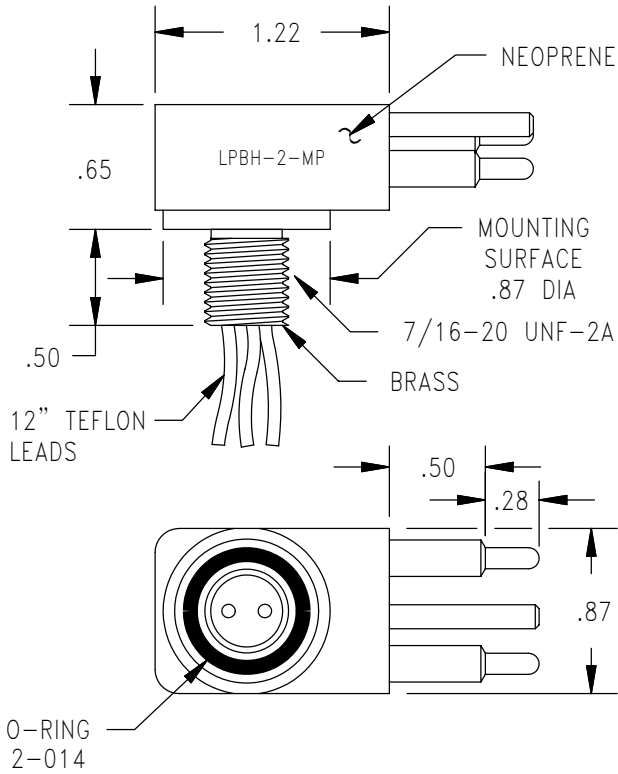

CONTACT CONFIGURATION
(MP FACE VIEW)

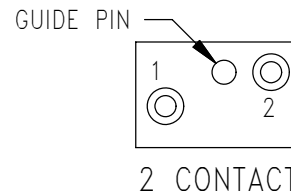

MOUNTING TORQUE FOR LPBH-FS/MP	not to exceed 100 in lbs
MATED PRESSURE RATING (psi)	10,000
DUMMY PLUG FOR LPBH-2-FS, LPIL-2-FS	LPDC-2-MP
DUMMY PLUG FOR LPBH-2-MP, LPIL-2-MP	LPDC-2-FS
NOTE: Bulkhead body available in stainless steel. Standard 1/2" thread length. * Dummy Plugs found on page 65 71.	

LPBH/LPIL-3/4/5

LOW PROFILE WET PLUGGABLE SERIES

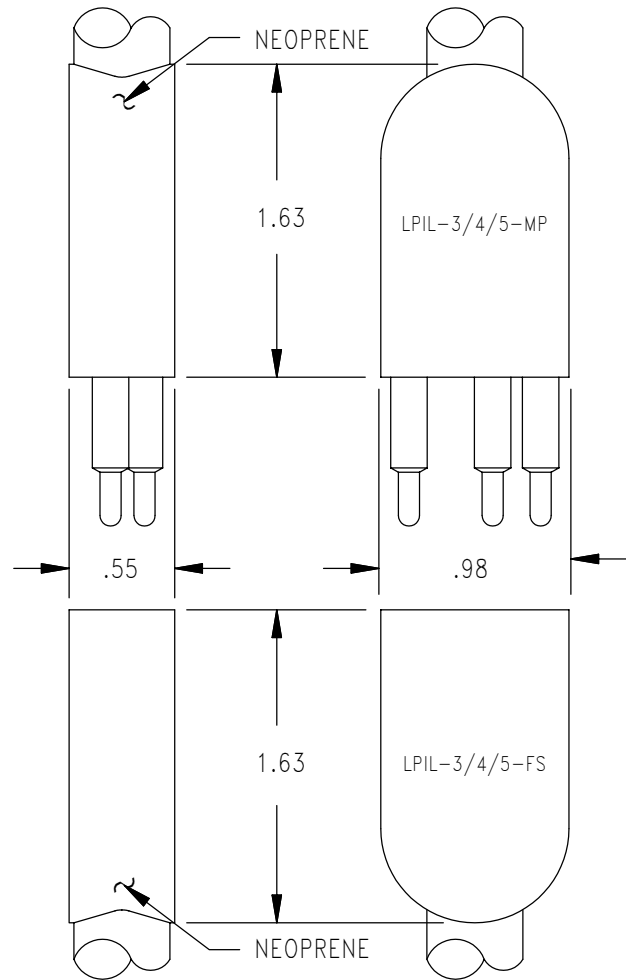
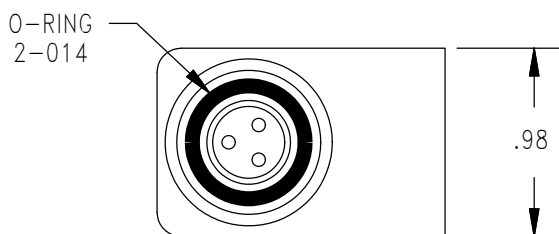
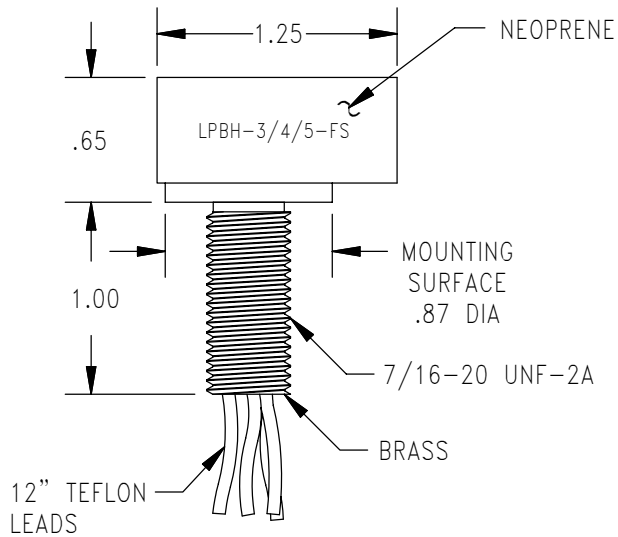
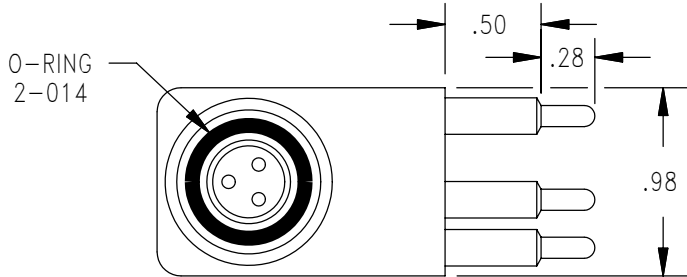
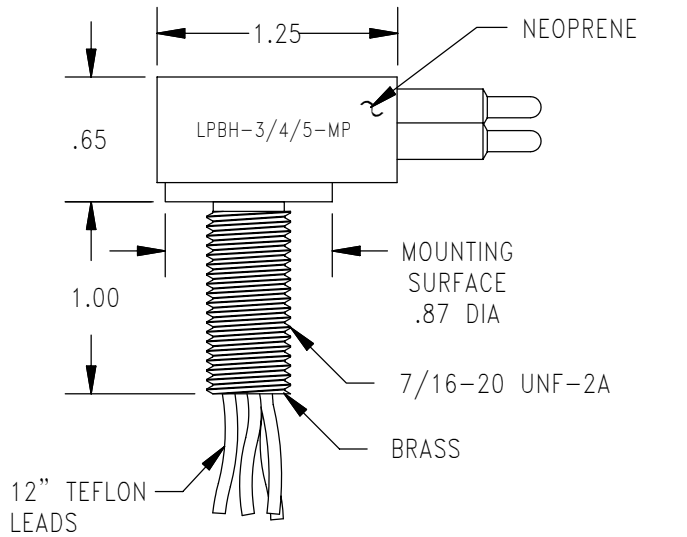

CONTACT CONFIGURATION (MP FACE VIEWS)

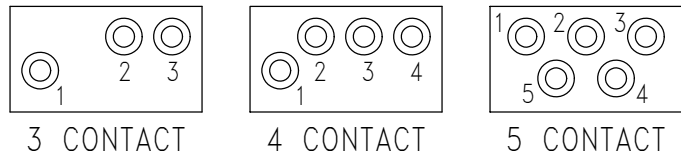

MOUNTING TORQUE FOR LPBH-FS/MP	not to exceed 100 in lbs
MATED PRESSURE RATING (psi)	10,000
DUMMY PLUG FOR LPBH-3/4/5-FS, LPIL-3/4/5-FS	LPDC-3/4/5-MP
DUMMY PLUG FOR LPBH-3/4/5-MP, LPIL-3/4/5-MP	LPDC-3/4/5-FS
NOTE: Bulkhead body available in stainless steel. Standard 1" thread length. * Dummy Plugs found on page 65 71.	

LPBH/LPIL-7

LOW PROFILE WET PLUGGABLE SERIES

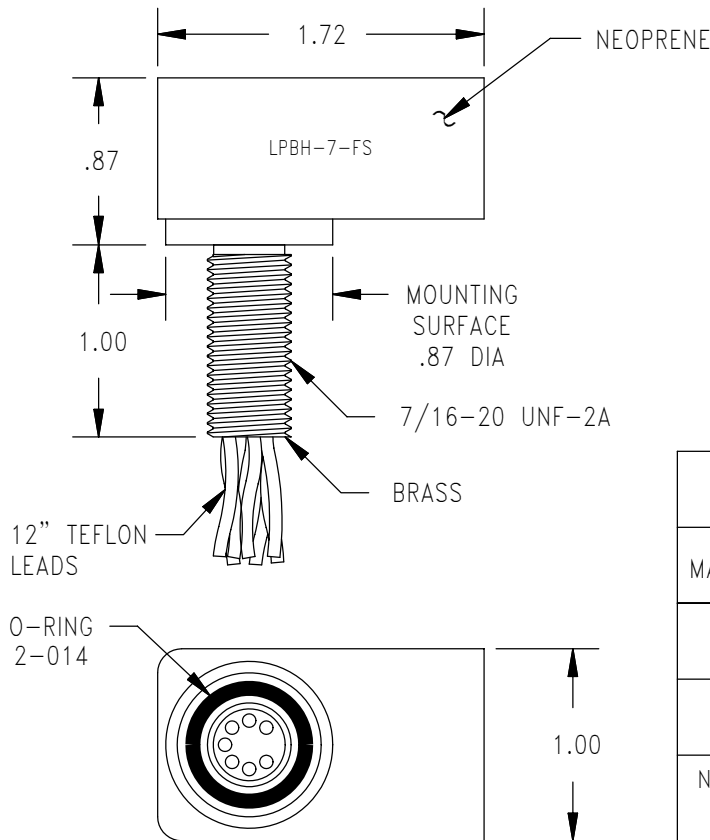
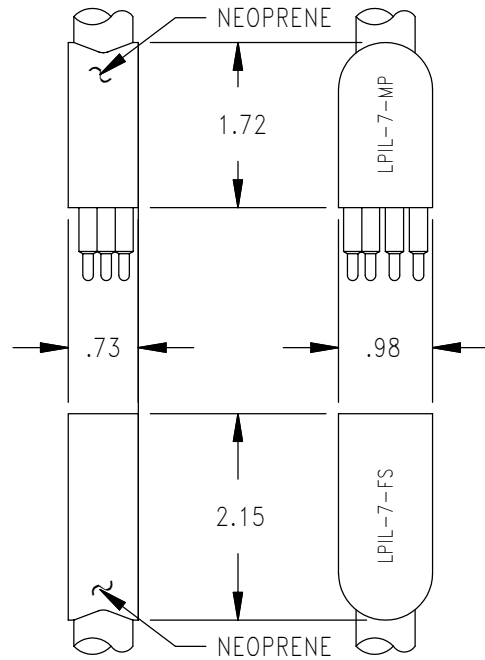
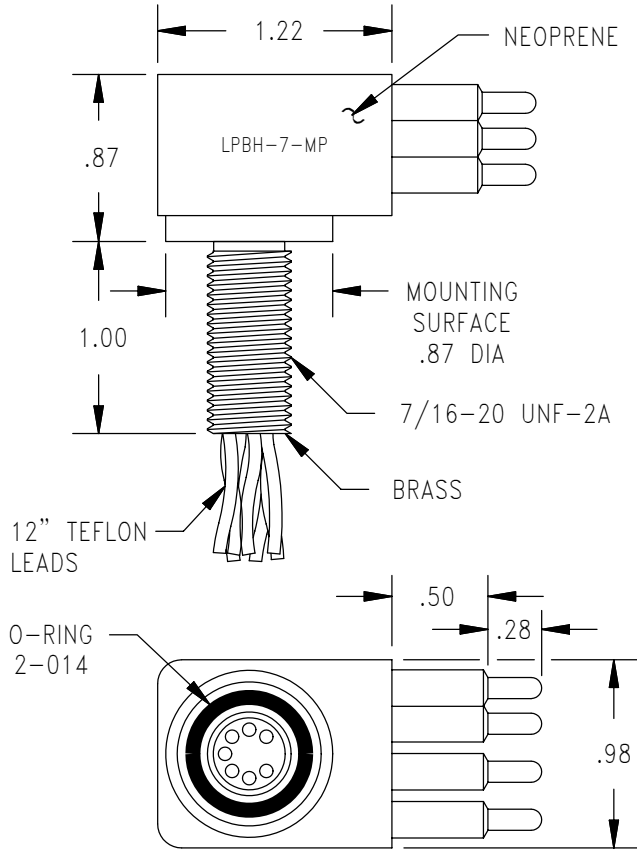

**CONTACT
CONFIGURATION
(MP FACE VIEW)**

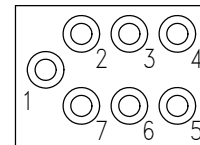

7 CONTACT

MOUNTING TORQUE FOR LPBH-FS/MP	not to exceed 100 in lbs
MATED PRESSURE RATING (psi)	10,000
DUMMY PLUG FOR LPBH-7-FS, LPIL-7-FS	LPDC-7-MP
DUMMY PLUG FOR LPBH-7-MP, LPIL-7-MP	LPDC-7-FS
NOTE: Bulkhead body available in stainless steel. Standard 1" thread length. * Dummy Plugs found on page 65 72.	

LPBH/LPIL-9/12

LOW PROFILE WET PLUGGABLE SERIES

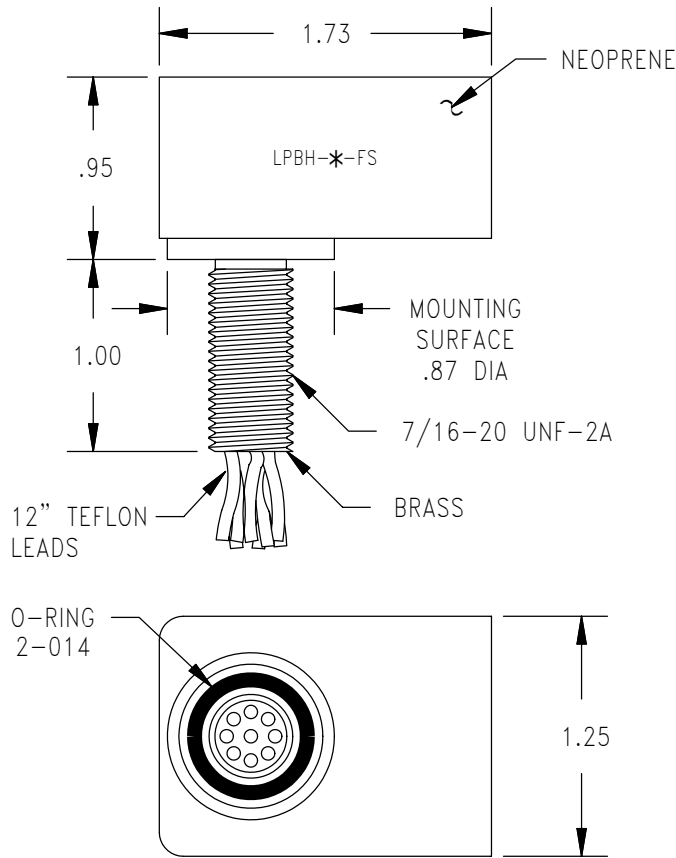
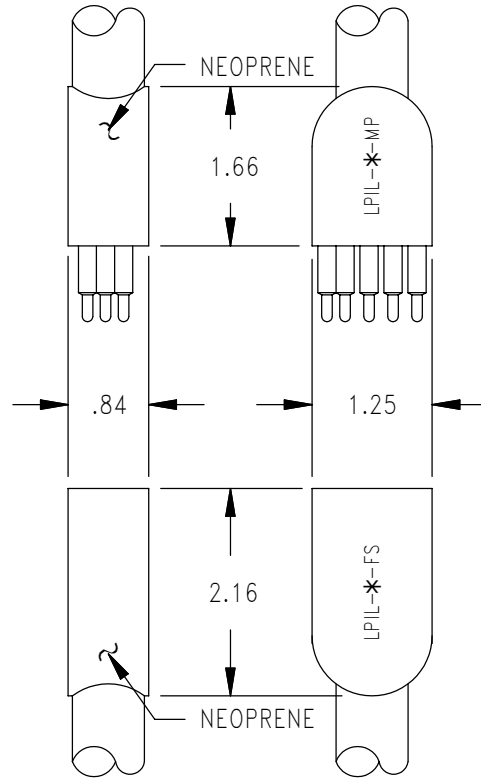
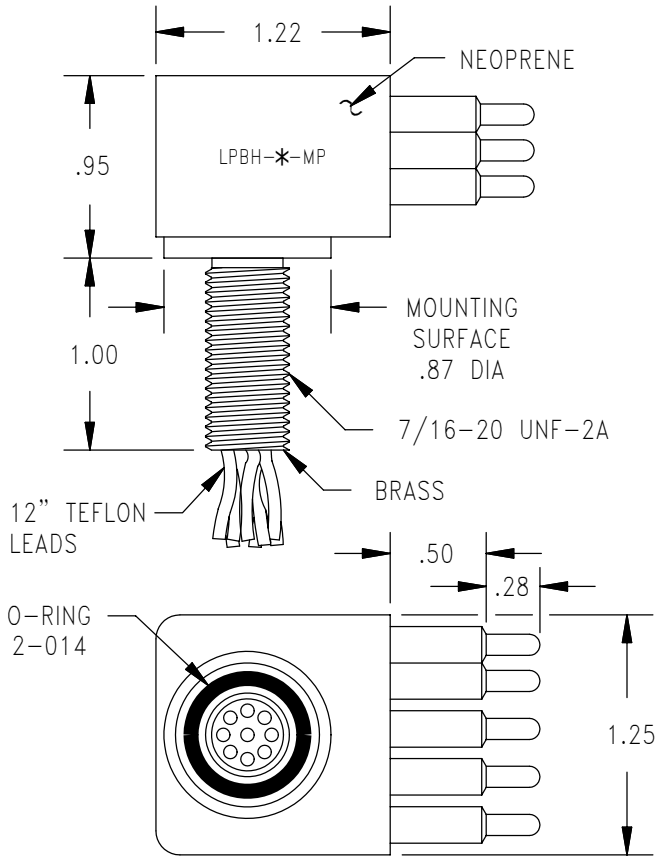

CONTACT CONFIGURATION (MP FACE VIEW)

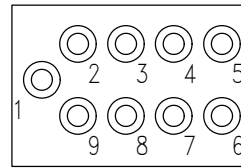

9 CONTACT

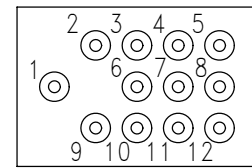

12 CONTACT

MOUNTING TORQUE FOR LPBH-FS/MP	not to exceed 100 in lbs
MATED PRESSURE RATING (psi)	10,000
DUMMY PLUG FOR LPBH-9-FS, LPIL-9-FS	LPDC-9-MP
DUMMY PLUG FOR LPBH-9-MP, LPIL-9-MP	LPDC-9-FS
NOTE: Bulkhead body available in stainless steel. Standard 1" thread length. * Dummy Plugs found on page 65 73.	

LPDC-2/3/4/5

LOW PROFILE WET PLUGGABLE SERIES

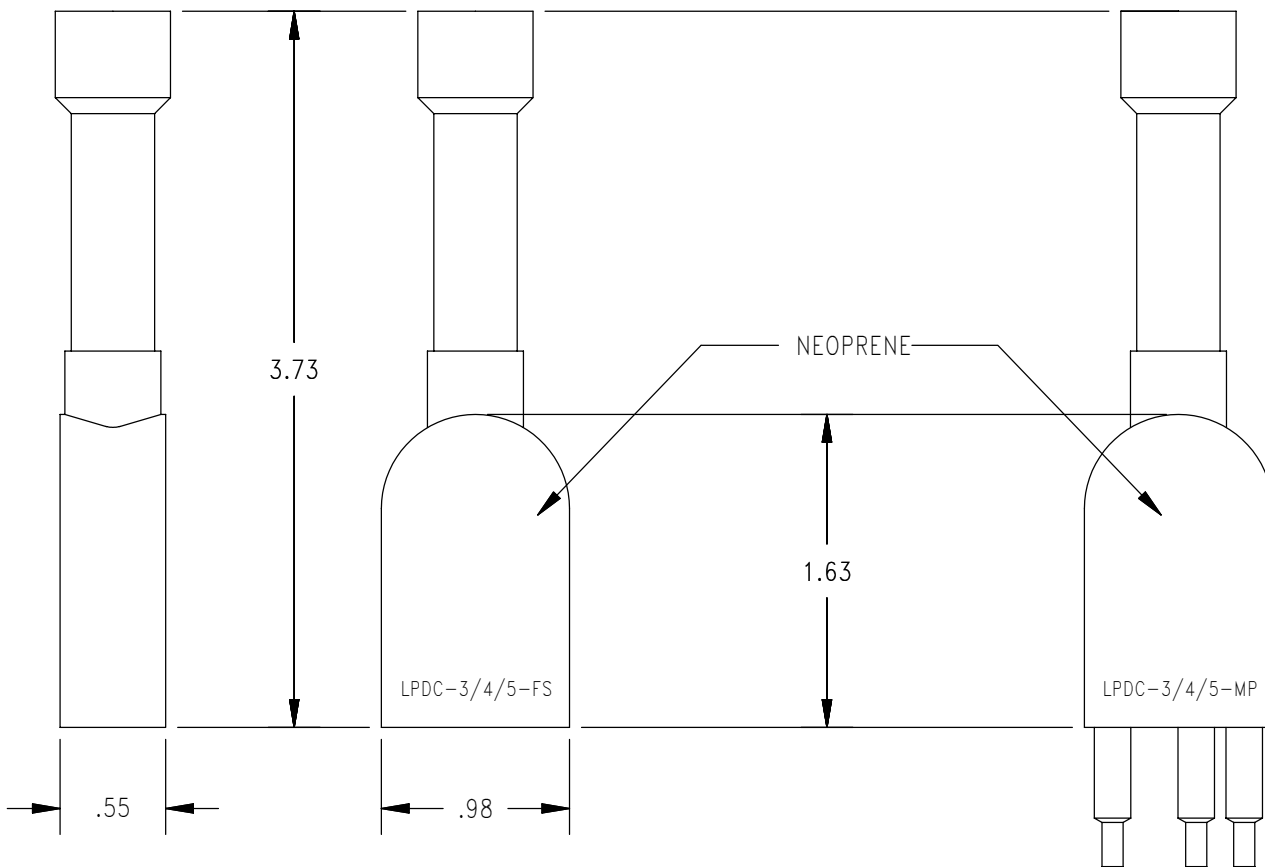
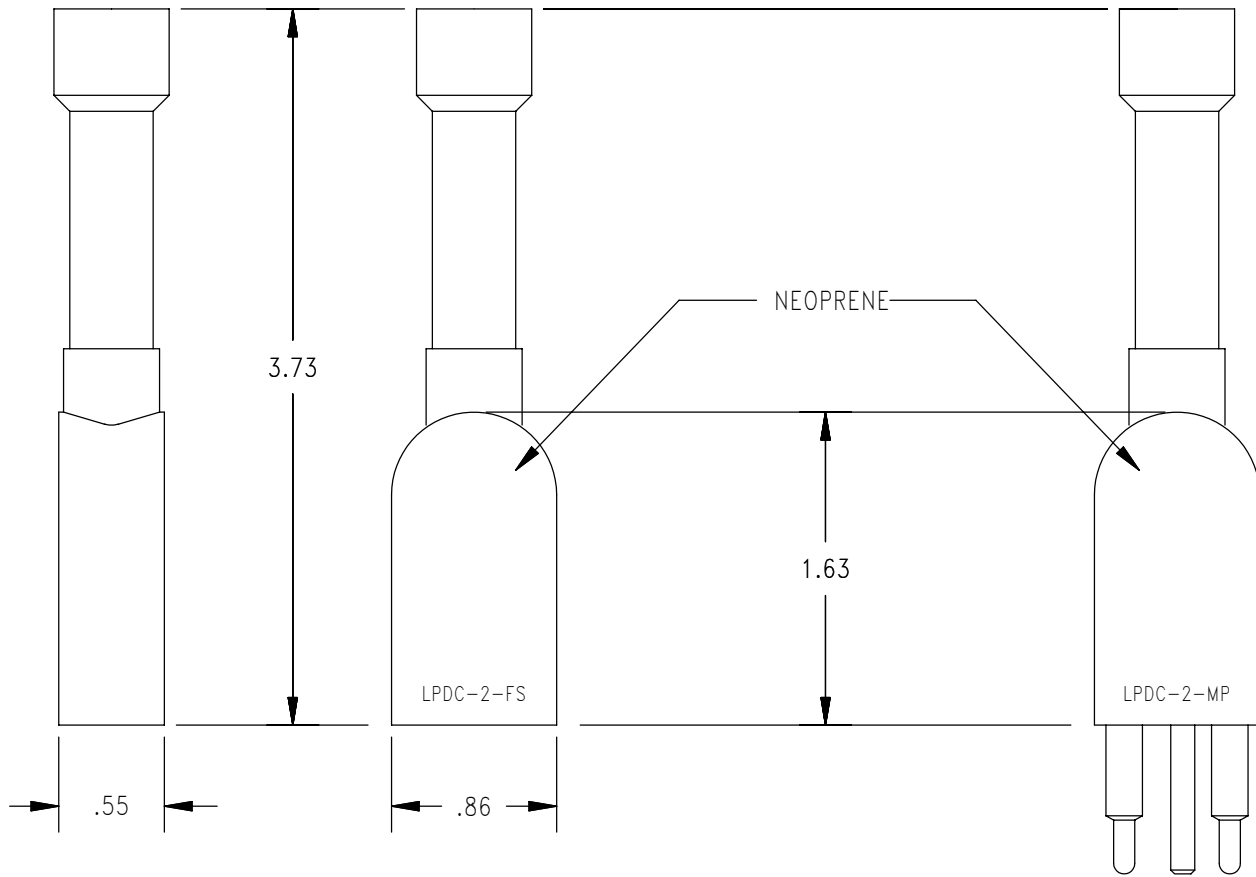

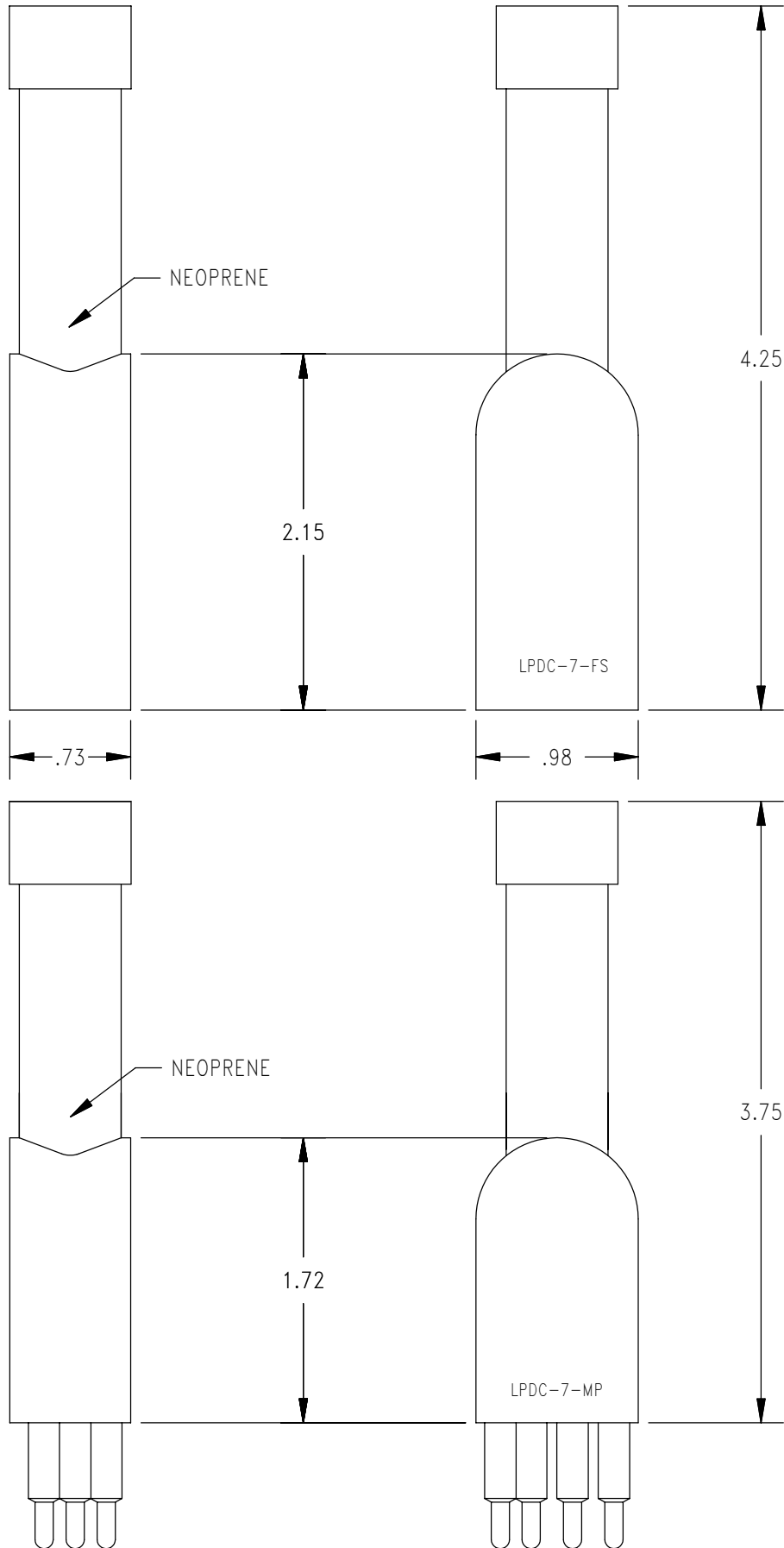

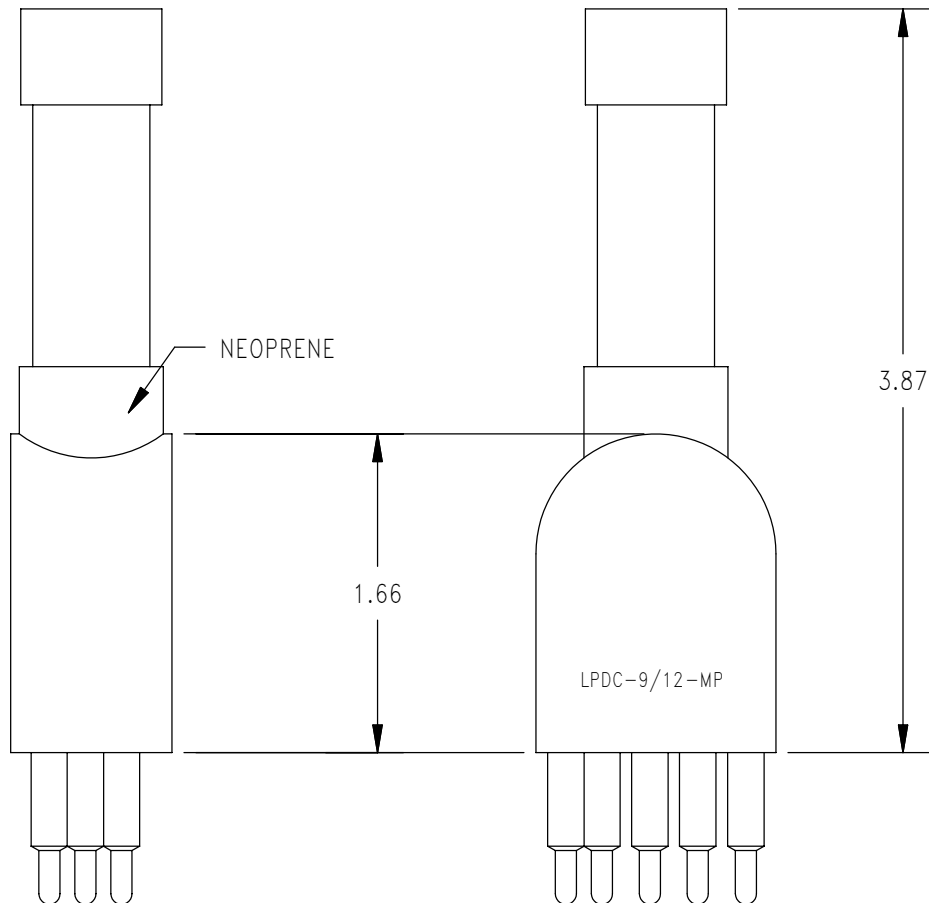
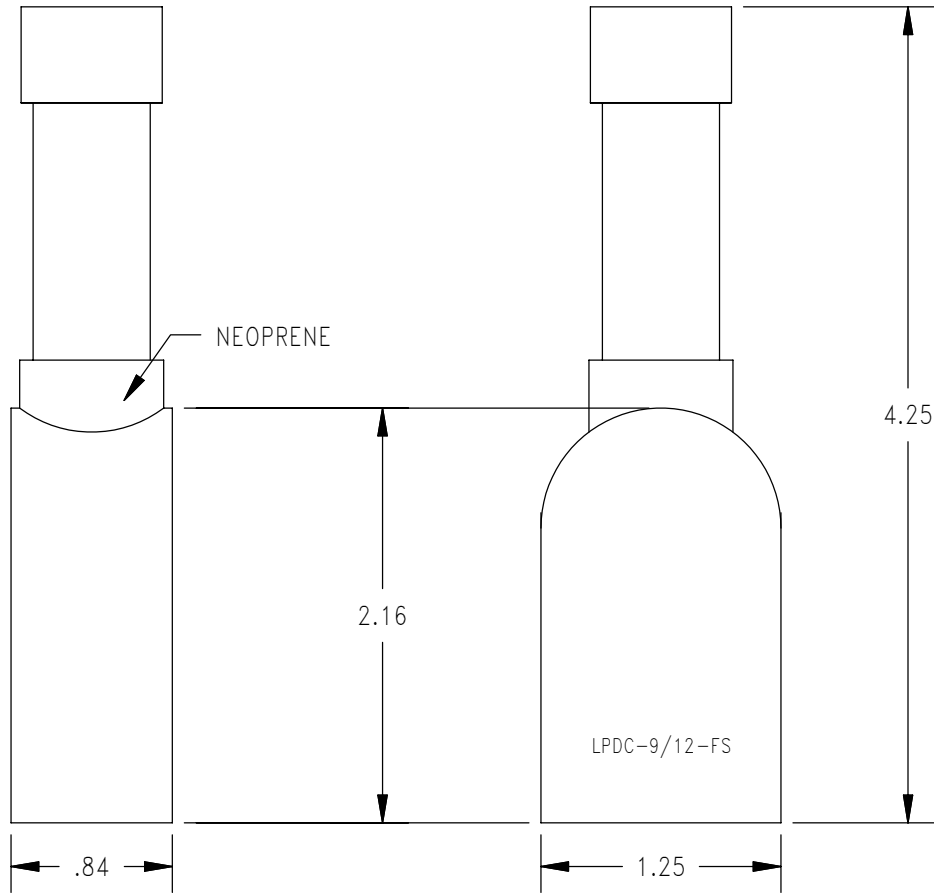

DESCRIPTION AND MATERIAL	<ul style="list-style-type: none">•Molded neoprene or polyurethane.•Two to eighteen contacts, 16 AWG.•Up to 750 VDC.•Up to 10,000 PSI, mated.•Bulkhead connector design open face pressure rated to 5000 PSI.•Contacts gold plated per MIL-G-45204.
CABLE	<ul style="list-style-type: none">•Inline connectors in this series are molded on a standard 24" length of cable, #20 AWG, unless otherwise specified.•Bulkhead connectors have 12" teflon leads, Type E per MIL 16878/4, 18 AWG.
USES	<ul style="list-style-type: none">•Light to medium duty applications.•Hazardous environments.
GUIDELINES	<ul style="list-style-type: none">•All mounting surfaces require a 32 finish.•Lubricate mating surface with 3M Silicone Spray or equivalent, DO NOT grease! Connectors must be lubricated on a regular basis.•Lubricate o-ring with Dow Corning #111 Valve Lubricant or equivalent.•Replace o-rings when re-using connectors.•Avoid nicks and cuts around contacts as these are the sealing surfaces.•Elastomers can be seriously degraded if exposed to direct sunlight or high ozone levels for extended periods of time.•Connectors should not be allowed to dry out. If this occurs soak in water before use.•Do not over tighten bulkhead nuts.•Do not pull on cable to disconnect.•Avoid sharp bends at cable entry to connector.
ORDERING INFORMATION	<ul style="list-style-type: none">•Bulkhead connectors do not come with nuts and washers. Nuts and washers should be ordered separately.

LPMBH/LPMIL

MINI WET
PLUGGABLE

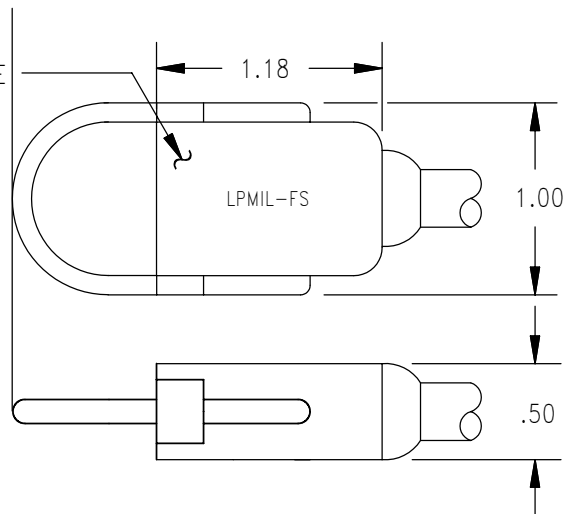
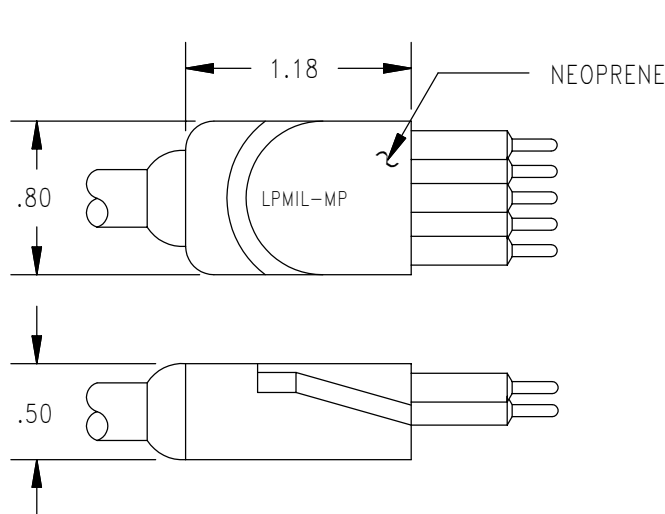
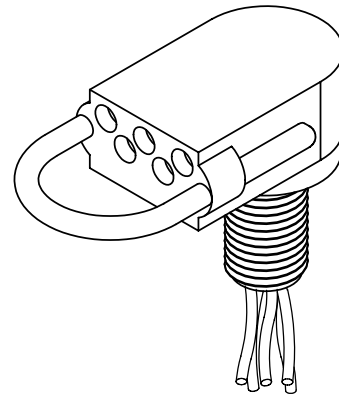
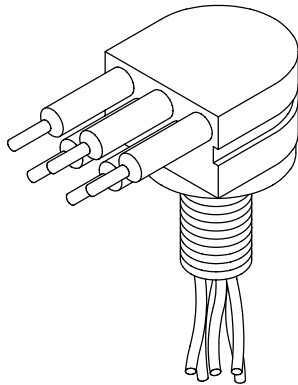
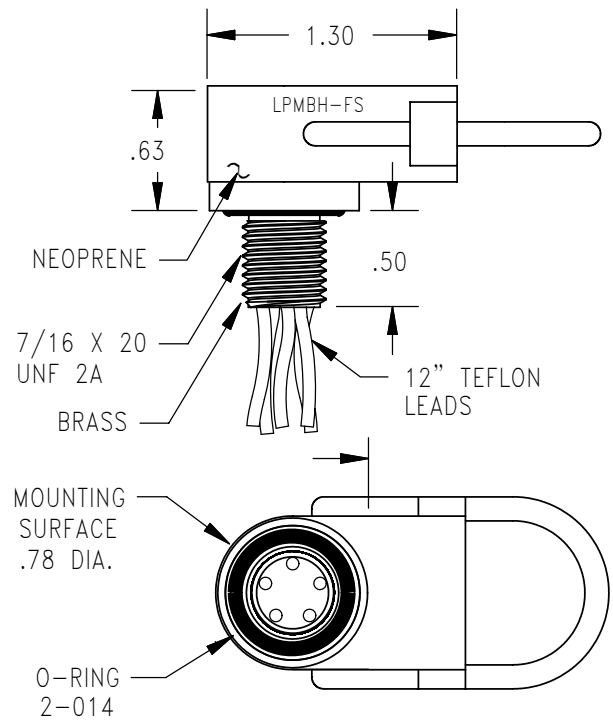
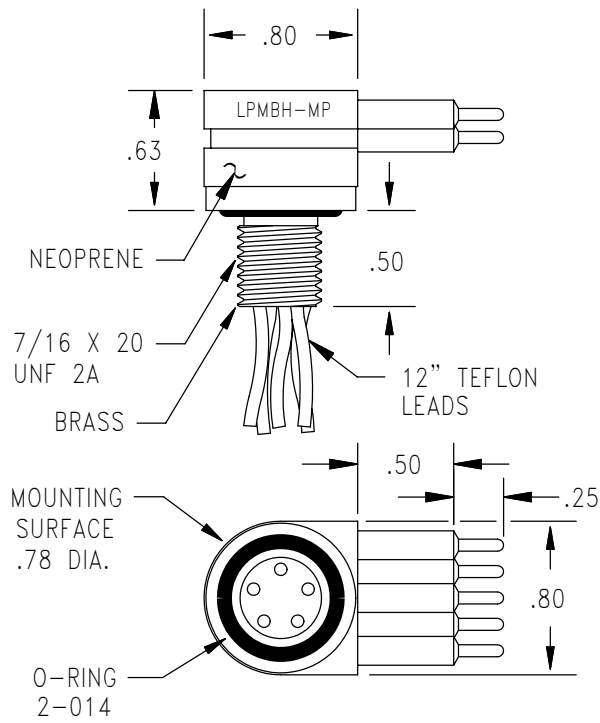

CONTACT
CONFIGURATION
(MP FACE VIEWS)

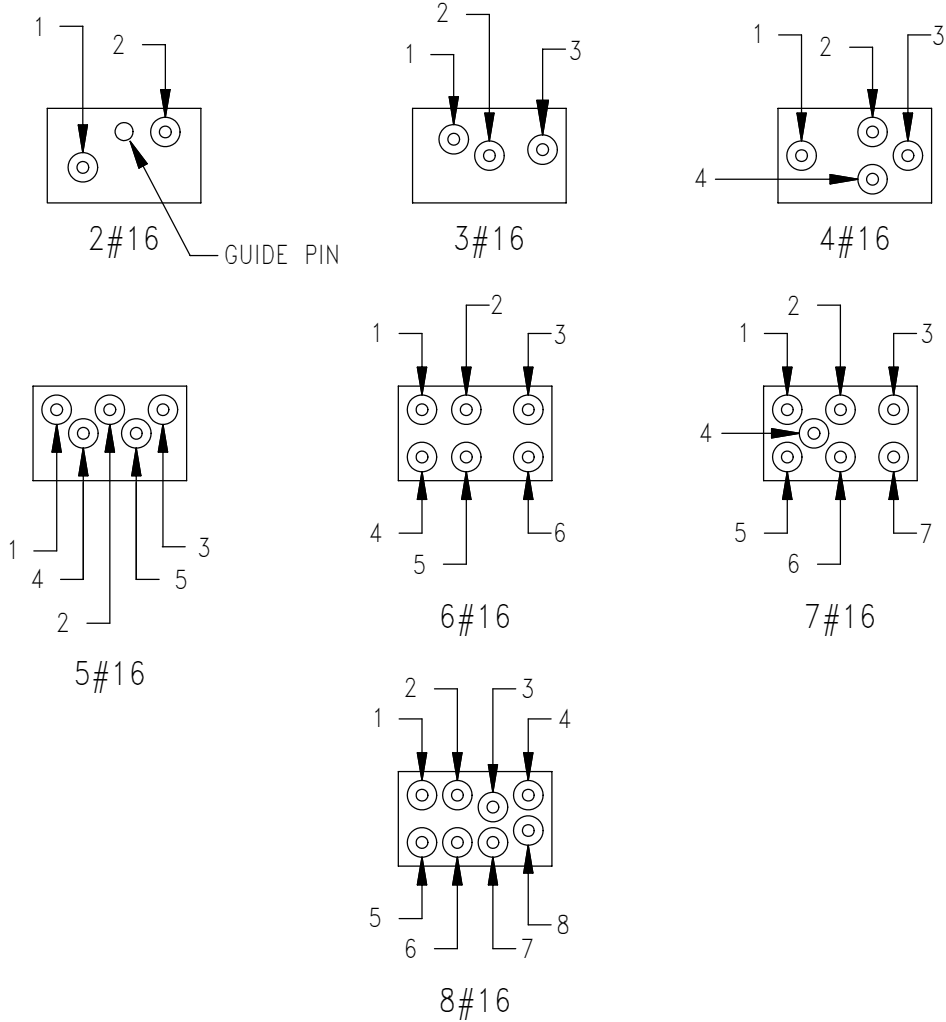

MOUNTING TORQUE LPMBH	not to exceed 100 in lbs	MATED PRESSURE RATING (psi)	10,000
DUMMY PLUG FOR LPMBH-MP, LPMIL-MP	LPMDC-*--FS	DUMMY PLUG FOR LPMBH-FS, LPMIL-FS	LPMDC-*--MP
NOTE: Standard 1/2" thread length. * Specify number of contacts. * Dummy plugs found on page 65 83.			

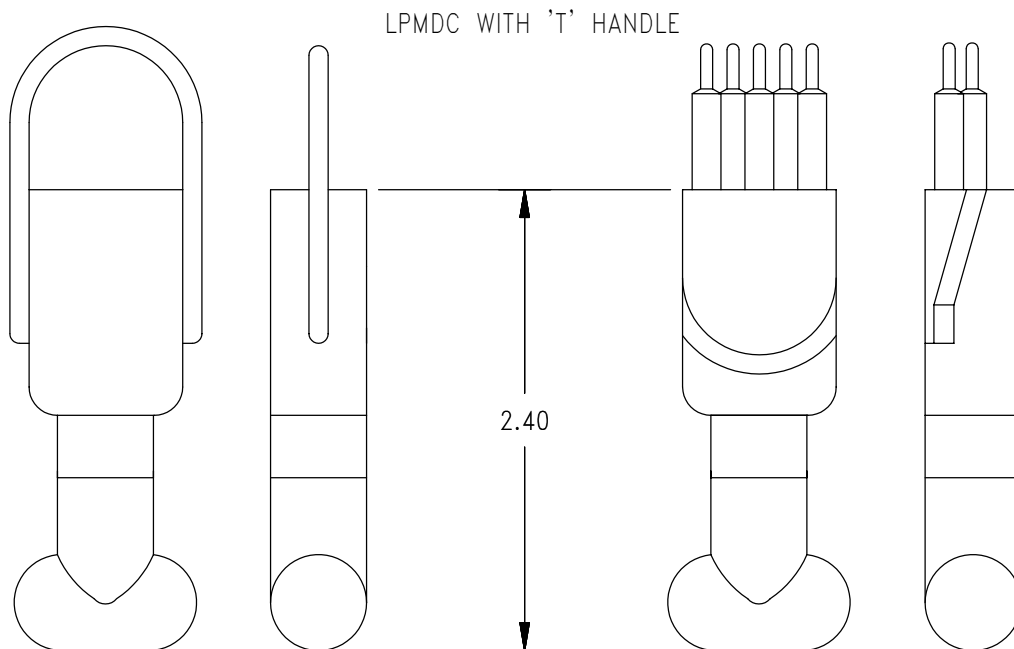
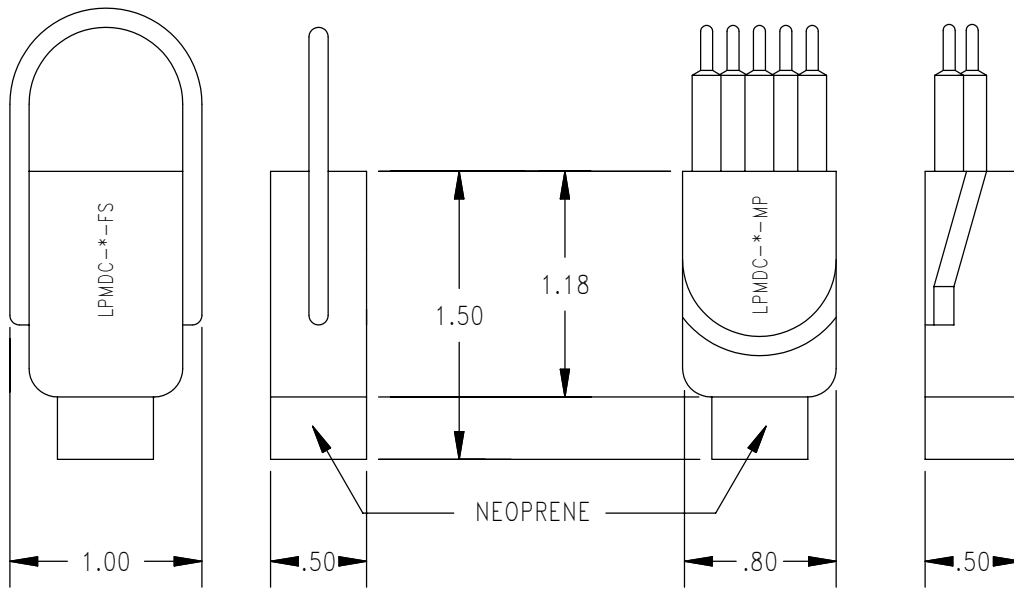

* Specify number of contacts.

THIS PAGE INTENTIONALLY LEFT BLANK

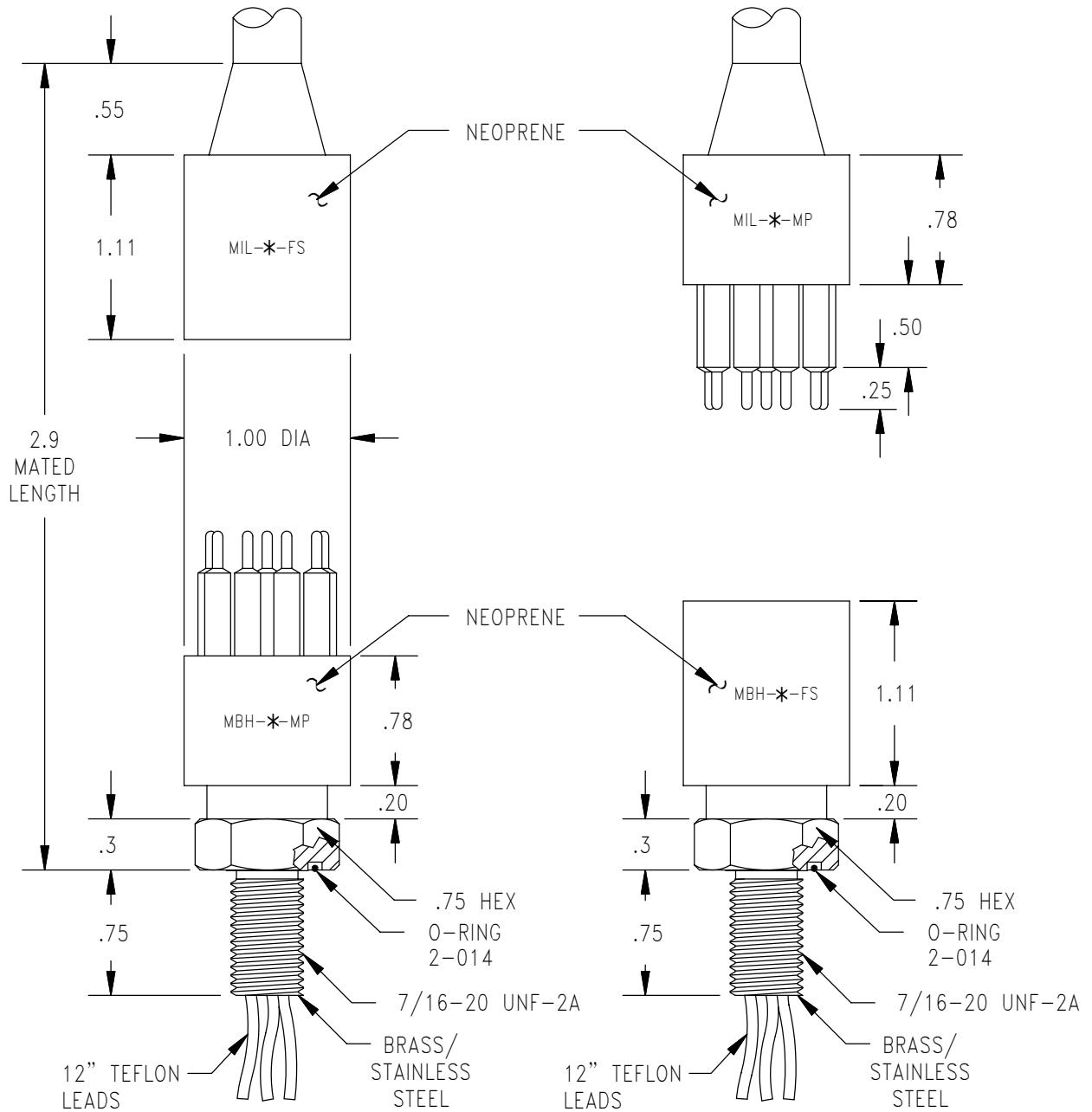

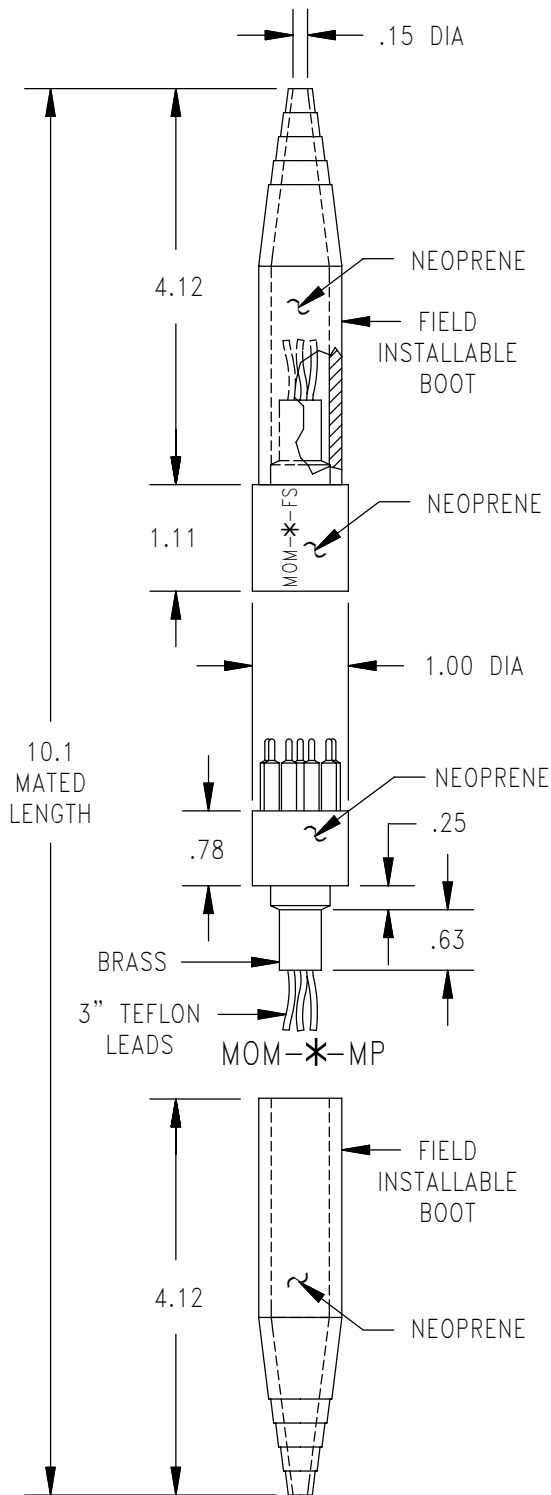

CONTACT
CONFIGURATION
(MP FACE VIEW)

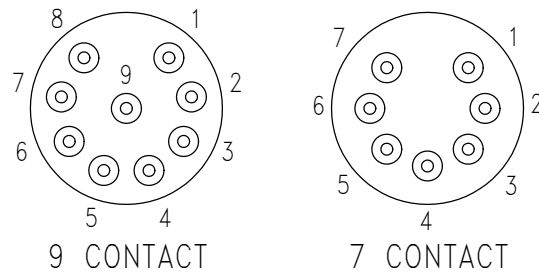

MOUNTING TORQUE FOR MBH-FS/MP	not to exceed 100 in lbs
MATED PRESSURE RATING (psi)	10,000
DUMMY PLUG FOR MBH-FS, MIL-FS, MOM-FS	MDC-*-MP
DUMMY PLUG FOR MBH-MP, MIL-MP, MOM-MP	MDC-*-FS
NOTE: Delrin locking sleeves available (DLSA-M or F). * Specify number of contacts. * Dummy plugs found on page 65 97	

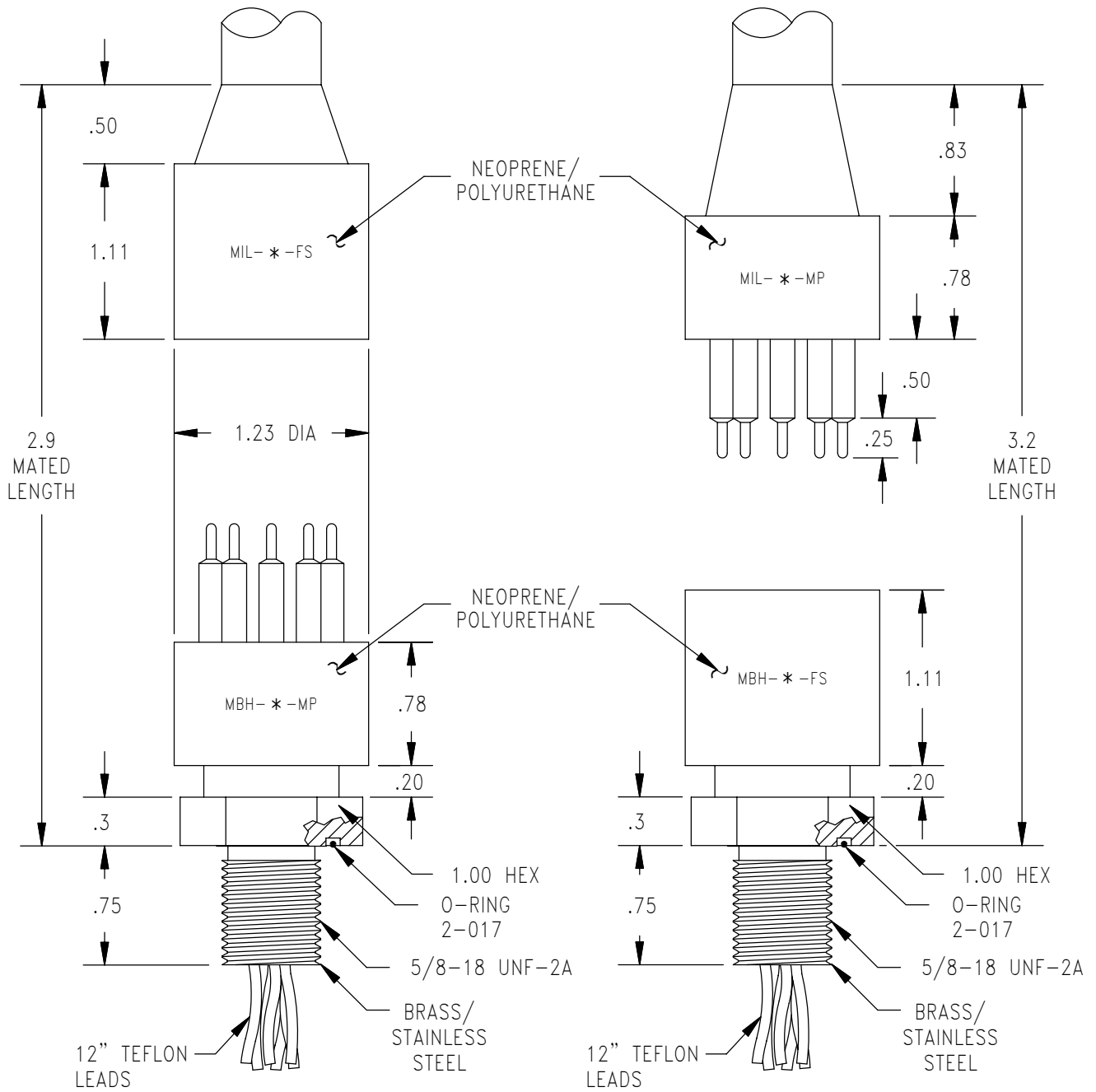

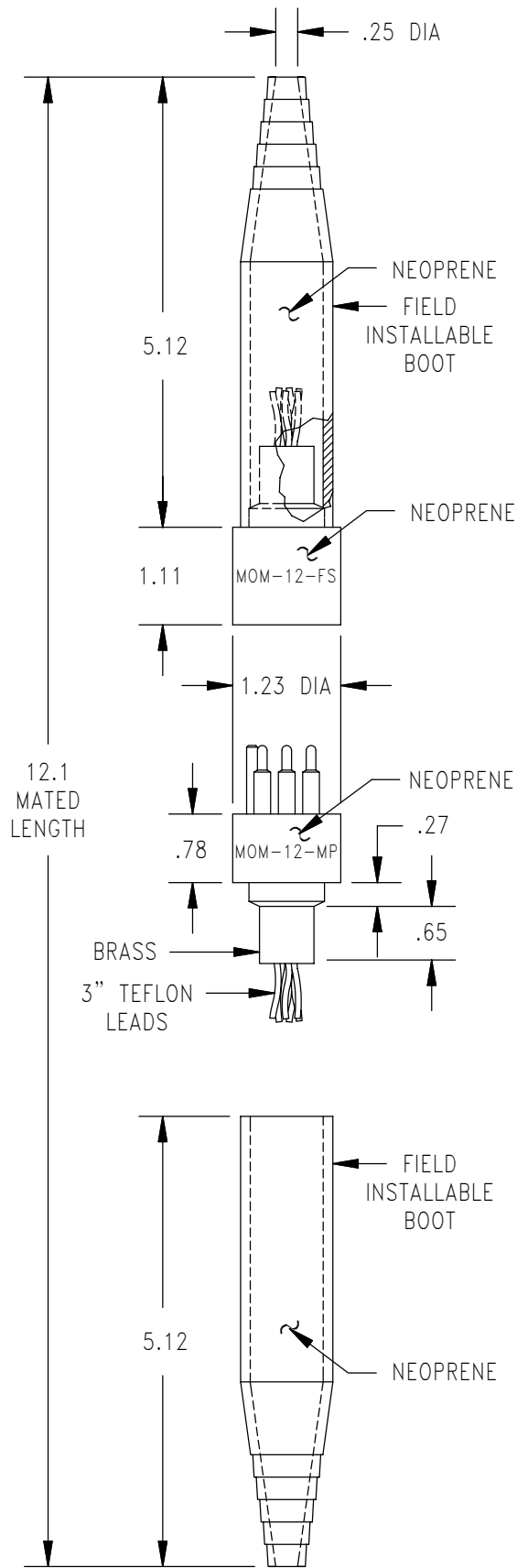

CONTACT
CONFIGURATION
(MP FACE VIEW)

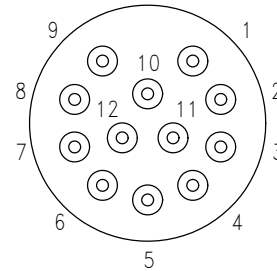

12 CONTACT

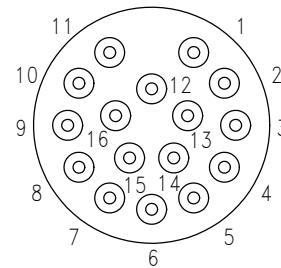

16 CONTACT
(MOM NOT AVAILABLE)

MOUNTING TORQUE FOR MBH-FS/MP	not to exceed 100 in lbs
MATED PRESSURE RATING (psi)	10,000
DUMMY PLUG FOR MBH-FS, MIL-FS, MOM-FS	MDC-*-MP
DUMMY PLUG FOR MBH-MP, MIL-MP, MOM-MP	MDC-*-FS
NOTE: Delrin locking sleeves available (DLSB-M or F). * Specify number of contacts. * Dummy plugs found on page 65 97	

CONTACT
CONFIGURATION
(MP FACE VIEW)

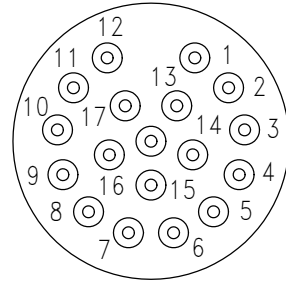

18 CONTACT

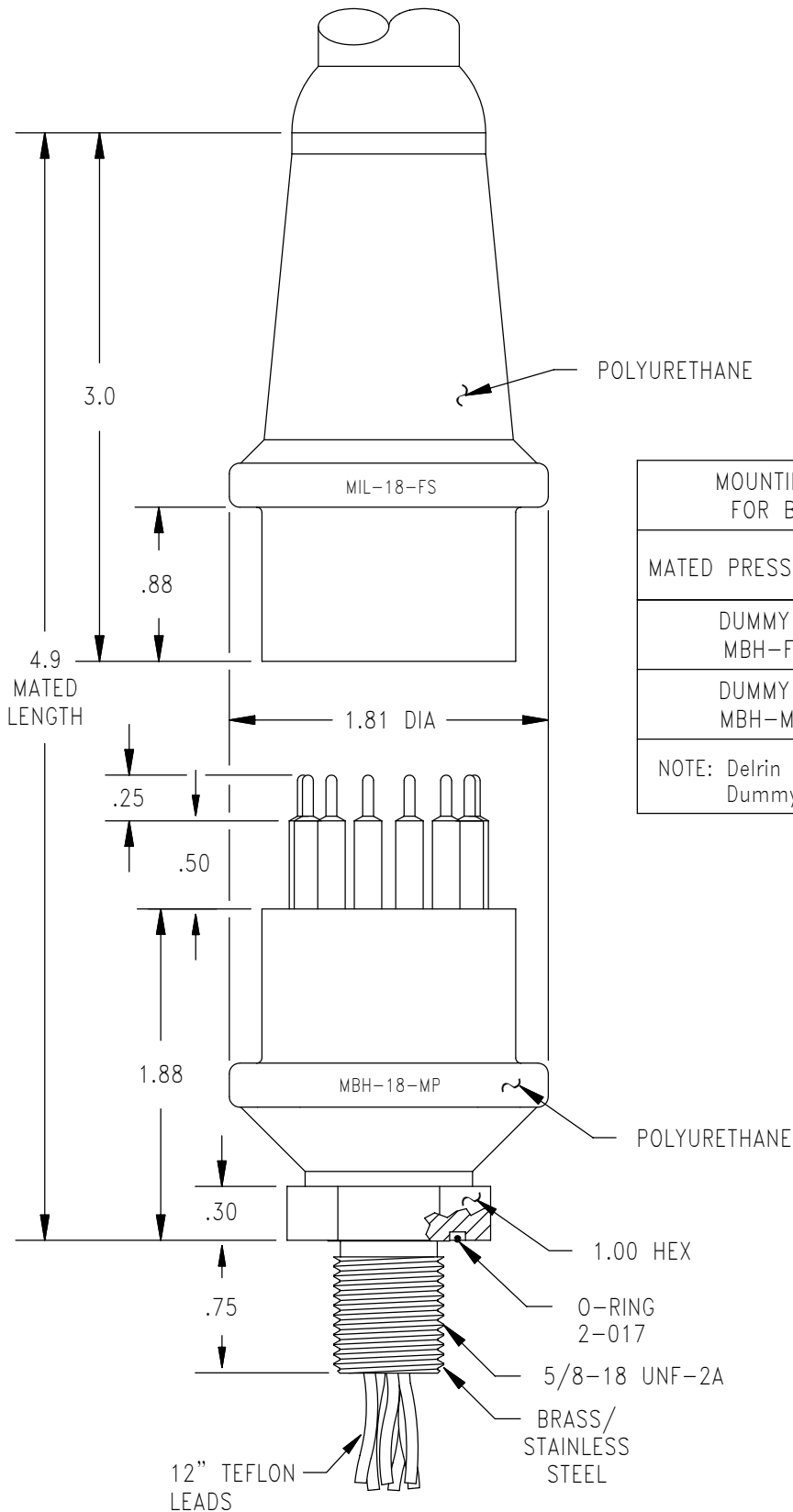

MOUNTING TORQUE FOR BH-FS/MP	not to exceed 100 in lbs
MATED PRESSURE RATING (psi)	10,000
DUMMY PLUG FOR MBH-FS, MIL-FS	MDC-18-MP
DUMMY PLUG FOR MBH-MP, MIL-MP	MDC-18-FS
NOTE: Delrin locking sleeve available (DLSD-M or F). Dummy plugs found on page 65 98	

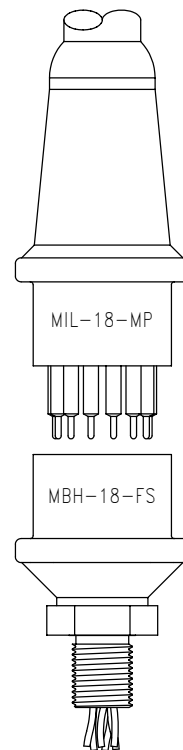

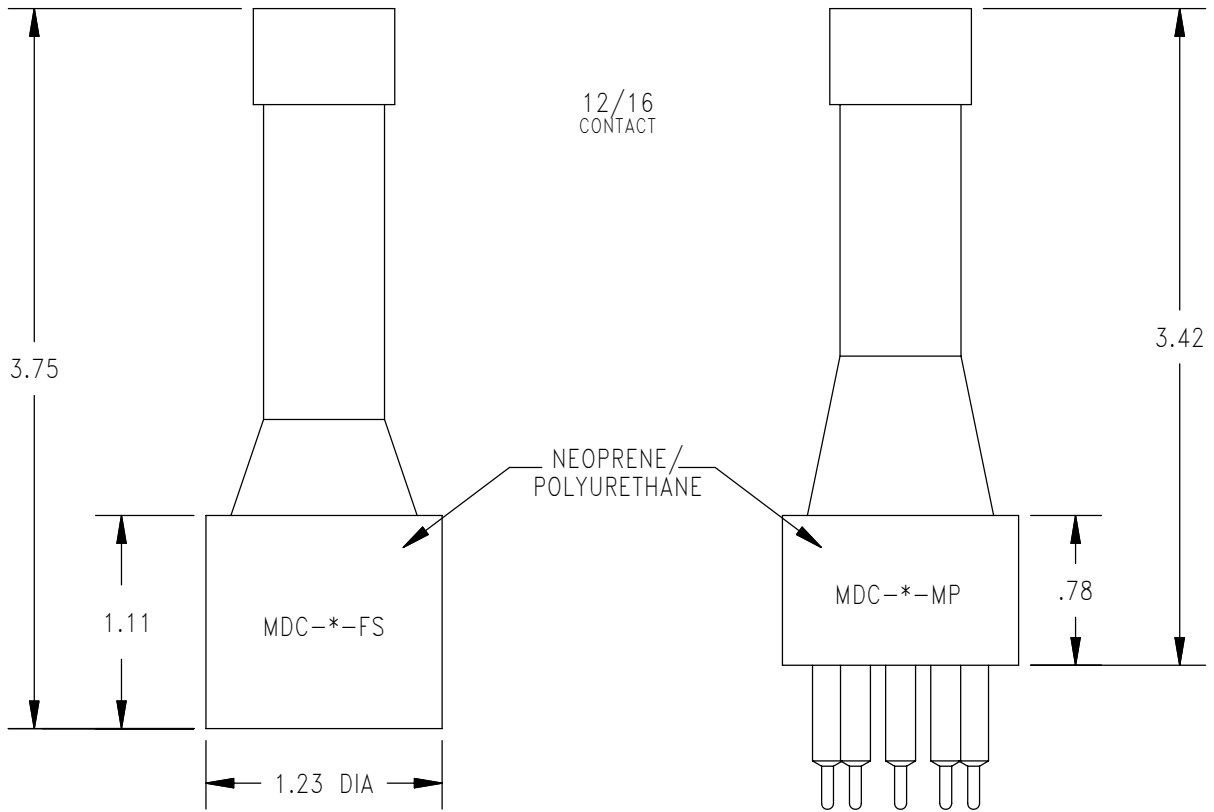
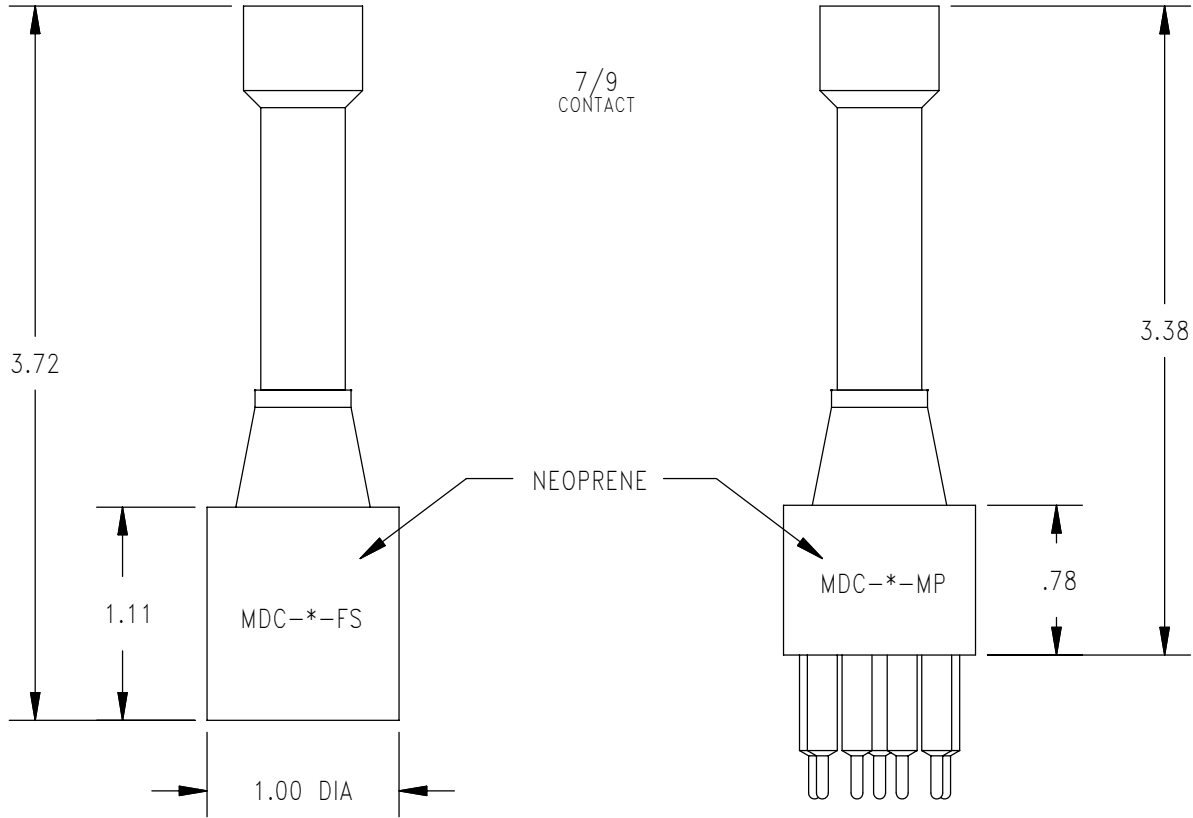

*Specify number of contacts

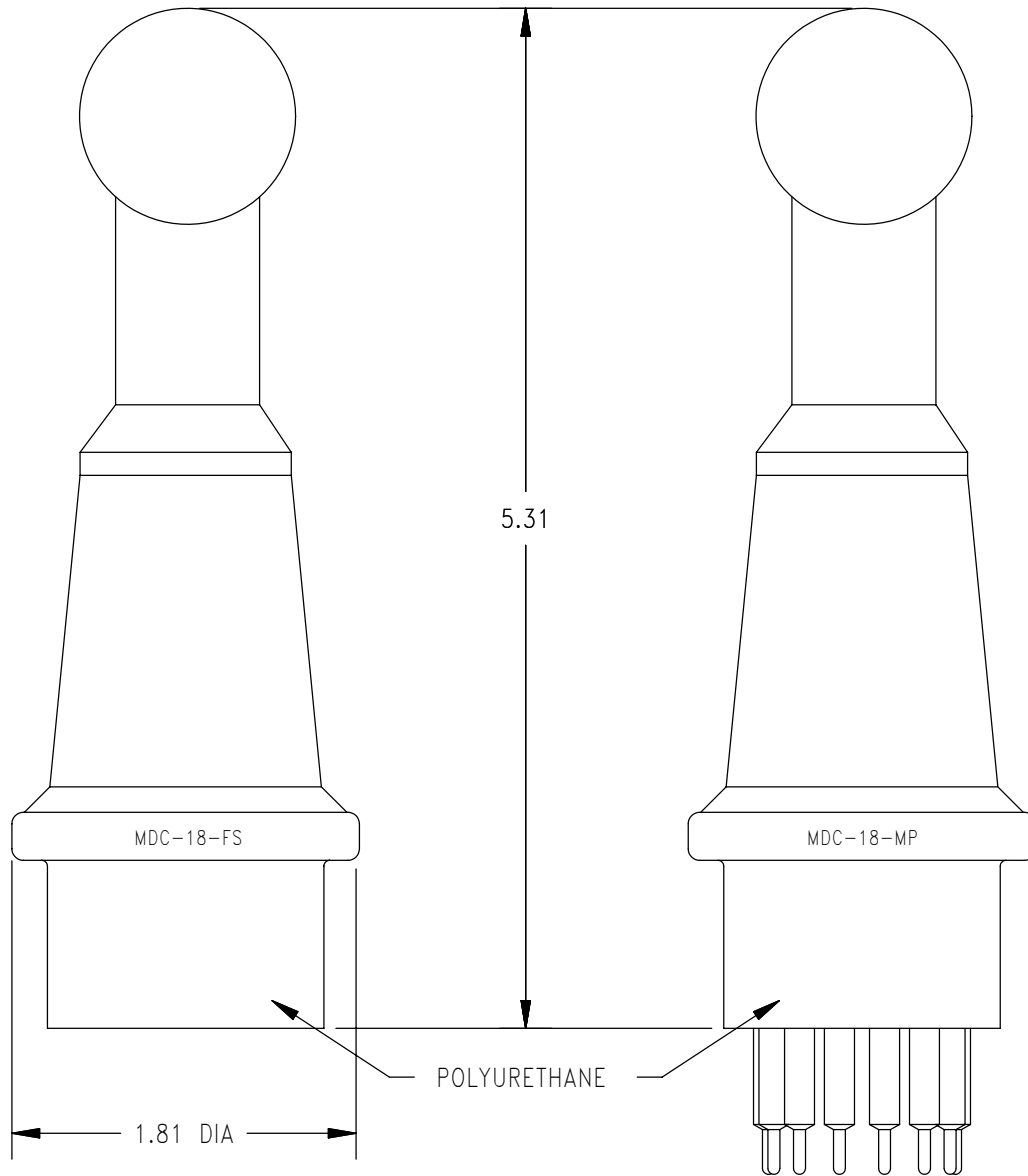

THIS PAGE INTENTIONALLY LEFT BLANK

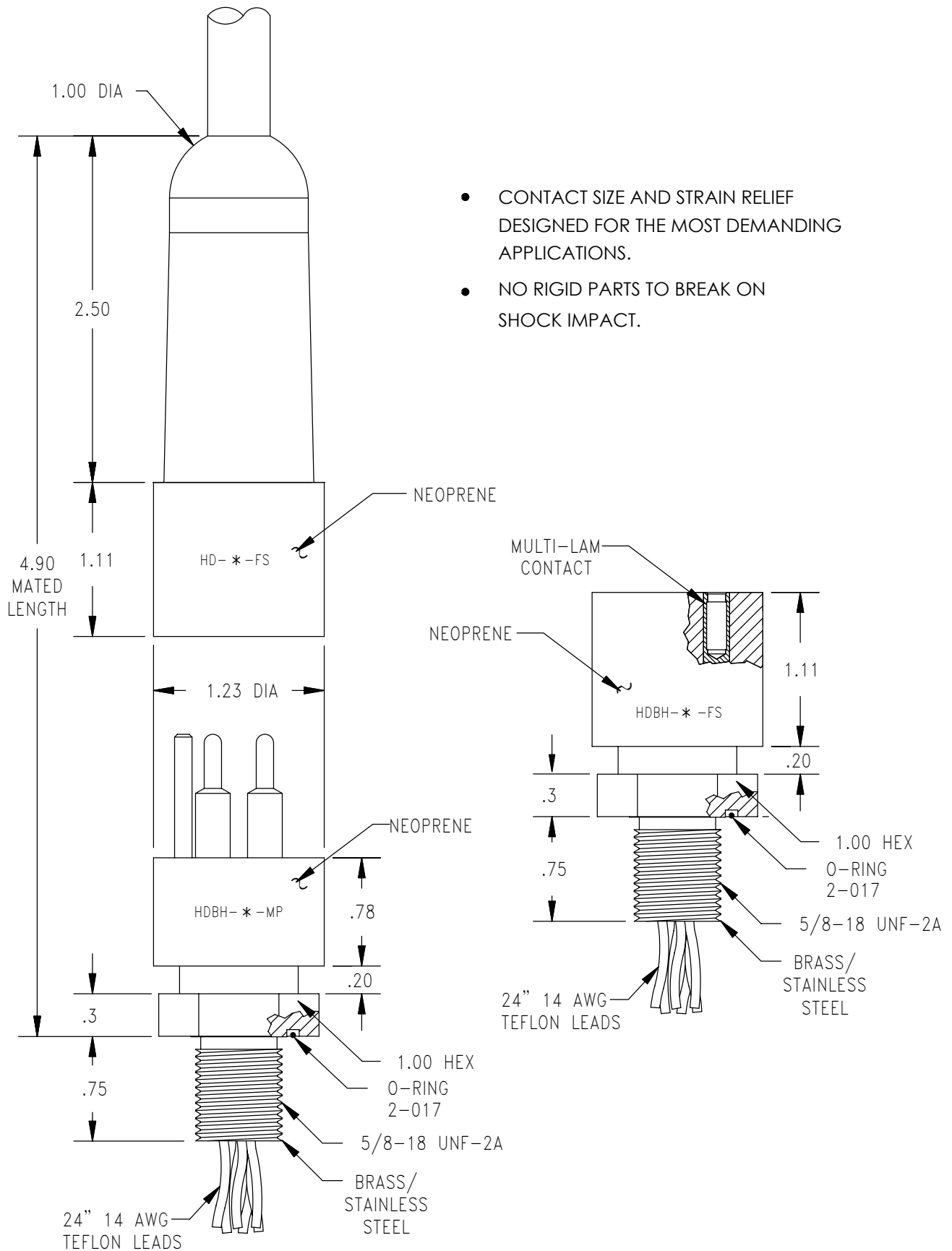

- CONTACT SIZE AND STRAIN RELIEF DESIGNED FOR THE MOST DEMANDING APPLICATIONS.
- NO RIGID PARTS TO BREAK ON SHOCK IMPACT.

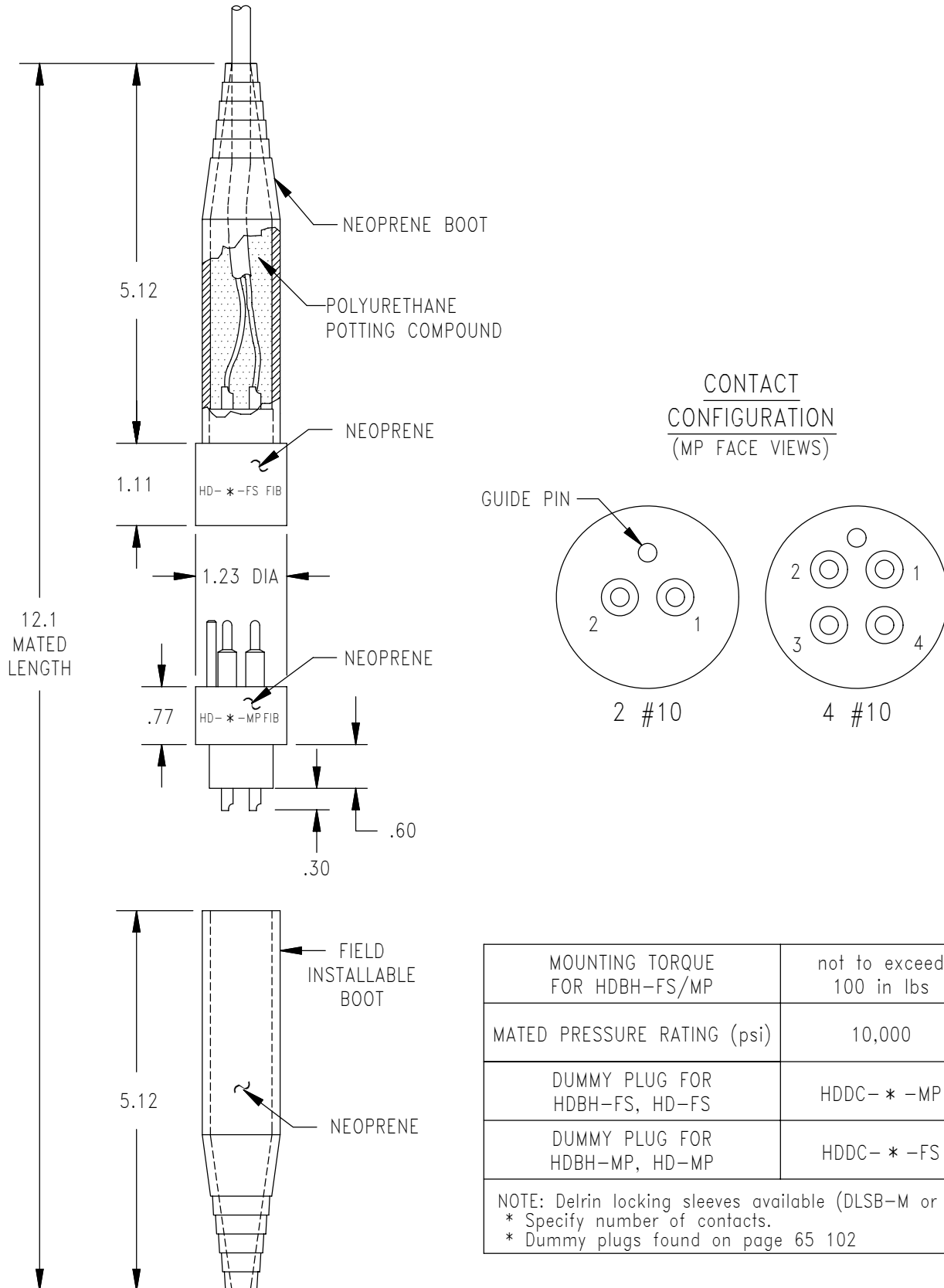

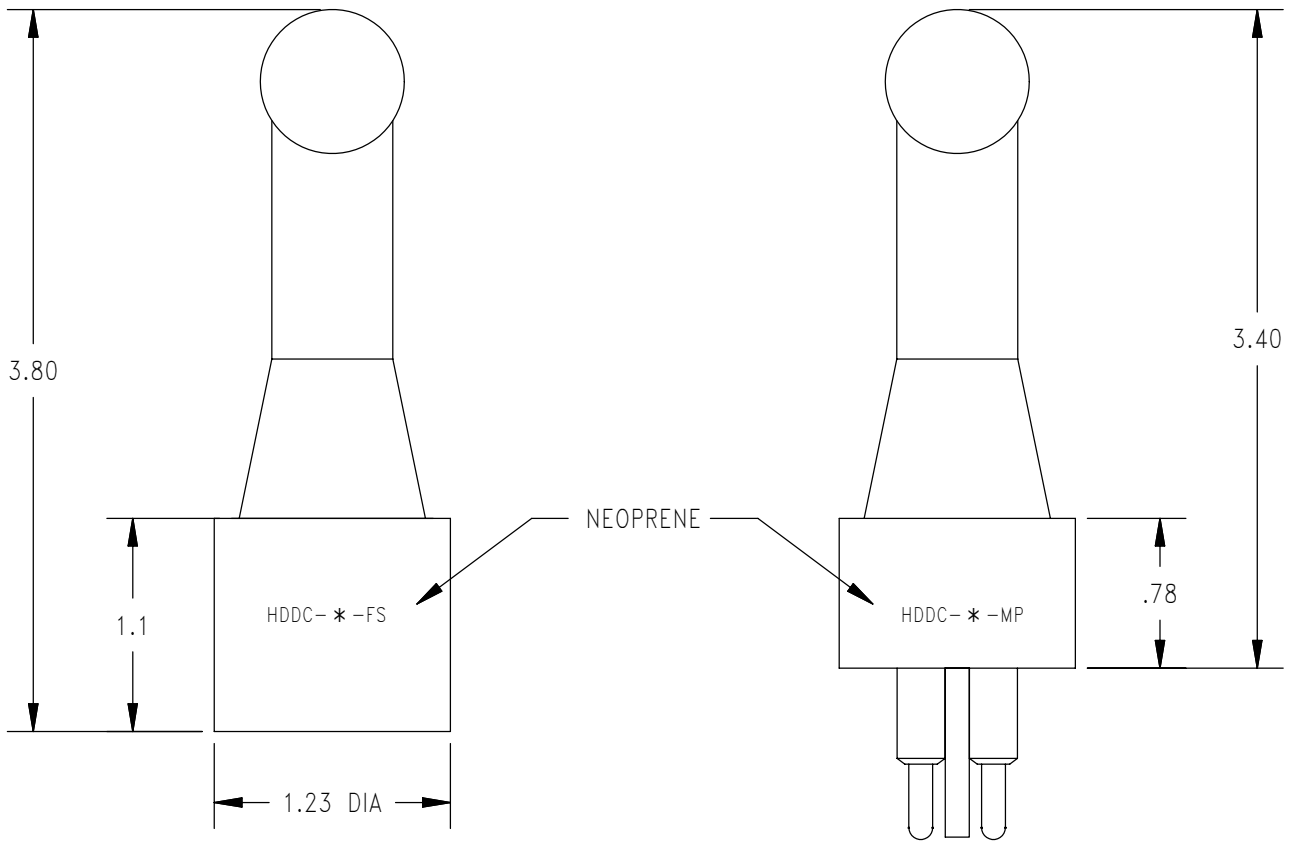

*Specify number of contacts

DESCRIPTION AND MATERIAL	<ul style="list-style-type: none">• Molded neoprene or polyurethane.• Two to eight contacts.• Up to 750 VDC.• Up to 10,000 PSI, mated.• Bulkhead connector design open face pressure rated to 5000 PSI.• Contacts gold plated per MIL-G-45204.
CABLE	<ul style="list-style-type: none">• Inline connectors in this series are molded on a standard 24” length of cable, 20 AWG, unless otherwise specified.• Bulkhead connectors have 12” teflon leads, Type E per MIL 16878/4, 20 AWG, (2-4, 9-18 contact) or 22 AWG (5-8 contact).
USES	<ul style="list-style-type: none">• Light to medium duty applications.• Hazardous environments.
GUIDELINES	<ul style="list-style-type: none">• All mounting surfaces require a 32 finish.• Lubricate mating surface with 3M Silicone Spray or equivalent, DO NOT grease! Connectors must be lubricated on a regular basis.• Lubricate o-ring with Dow Corning #111 Valve Lubricant or equivalent.• Replace o-rings when re-using connectors.• Avoid nicks and cuts around contacts as these are the sealing surfaces.• Elastomers can be seriously degraded if exposed to direct sunlight or high ozone levels for extended periods of time.• Do not over tighten bulkhead nuts.• Grip main body of connector during mating or unmating. Do not pull on cable to disconnect.• Avoid sharp bends at cable entry to connector.
ORDERING INFORMATION	<ul style="list-style-type: none">• Bulkhead connectors do not come with nuts and washers. Nuts and washers should be ordered separately.

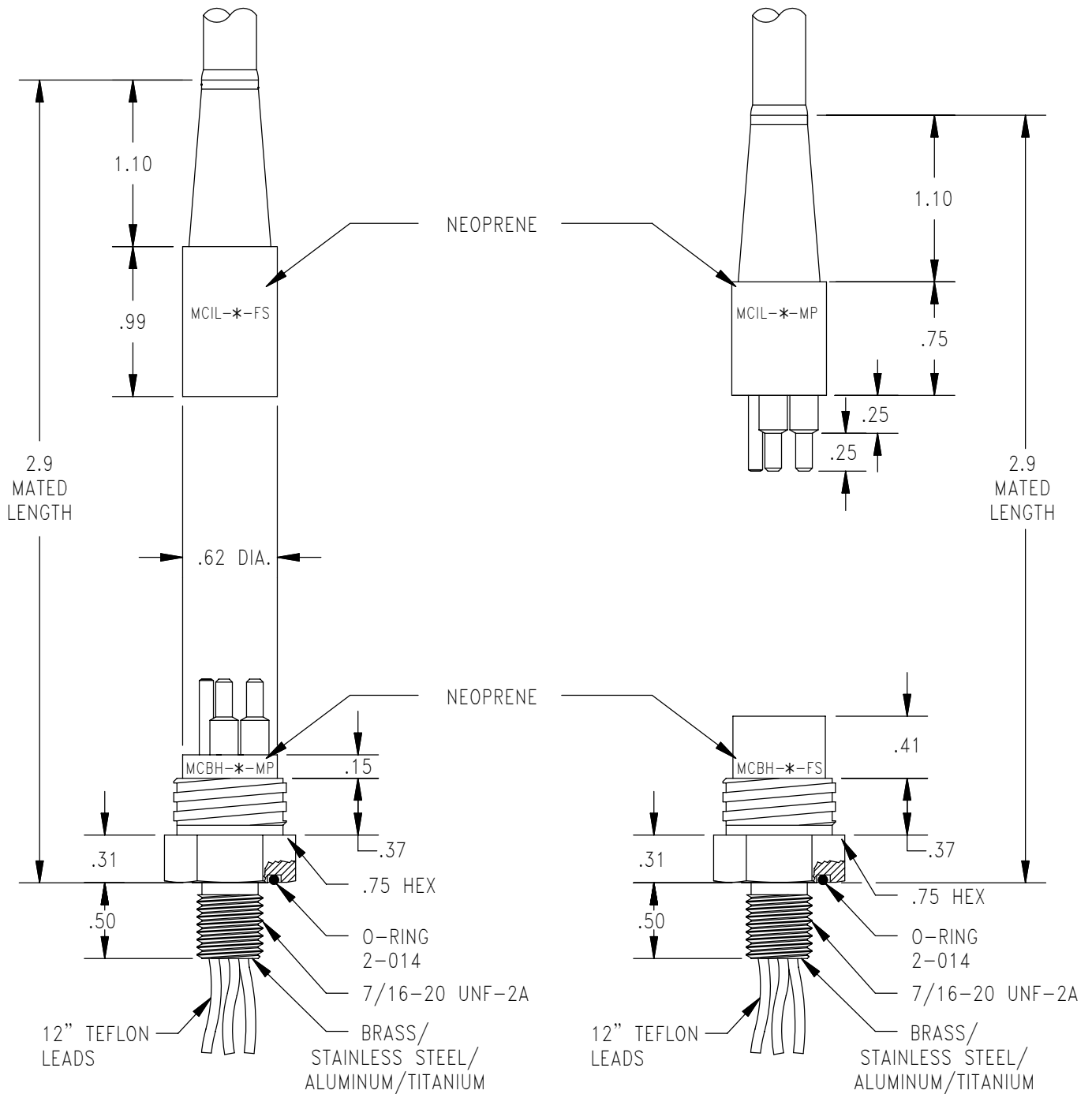

MALE

FEMALE

MCDLS-M

MCDLS-F

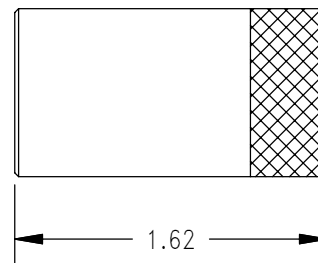
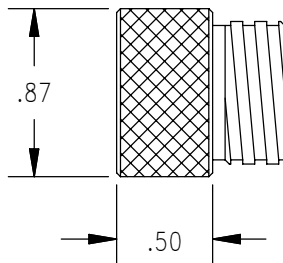

CONTACT
CONFIGURATION
(MP FACE VIEW)

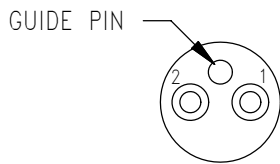

2 #12
W/ GUIDE PIN

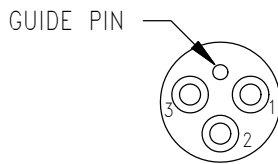

3 #12
W/ GUIDE PIN

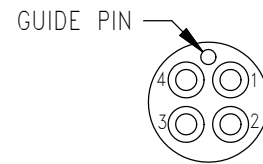

4 #12
W/ GUIDE PIN

MOUNTING TORQUE FOR MCIL/BH-FS/MP	not to exceed 100 in lbs
MATED PRESSURE RATING (psi)	10,000
DUMMY PLUG FOR MCIL/BH-FS	MCDC- * -MP
DUMMY PLUG FOR MCIL/BH-MP	MCDC- * -FS
* Specify number of contacts. * Dummy plugs found on page 65 125.	
NOTE: Bulkhead body available in Titanium. Standard 3/4" thread length.	

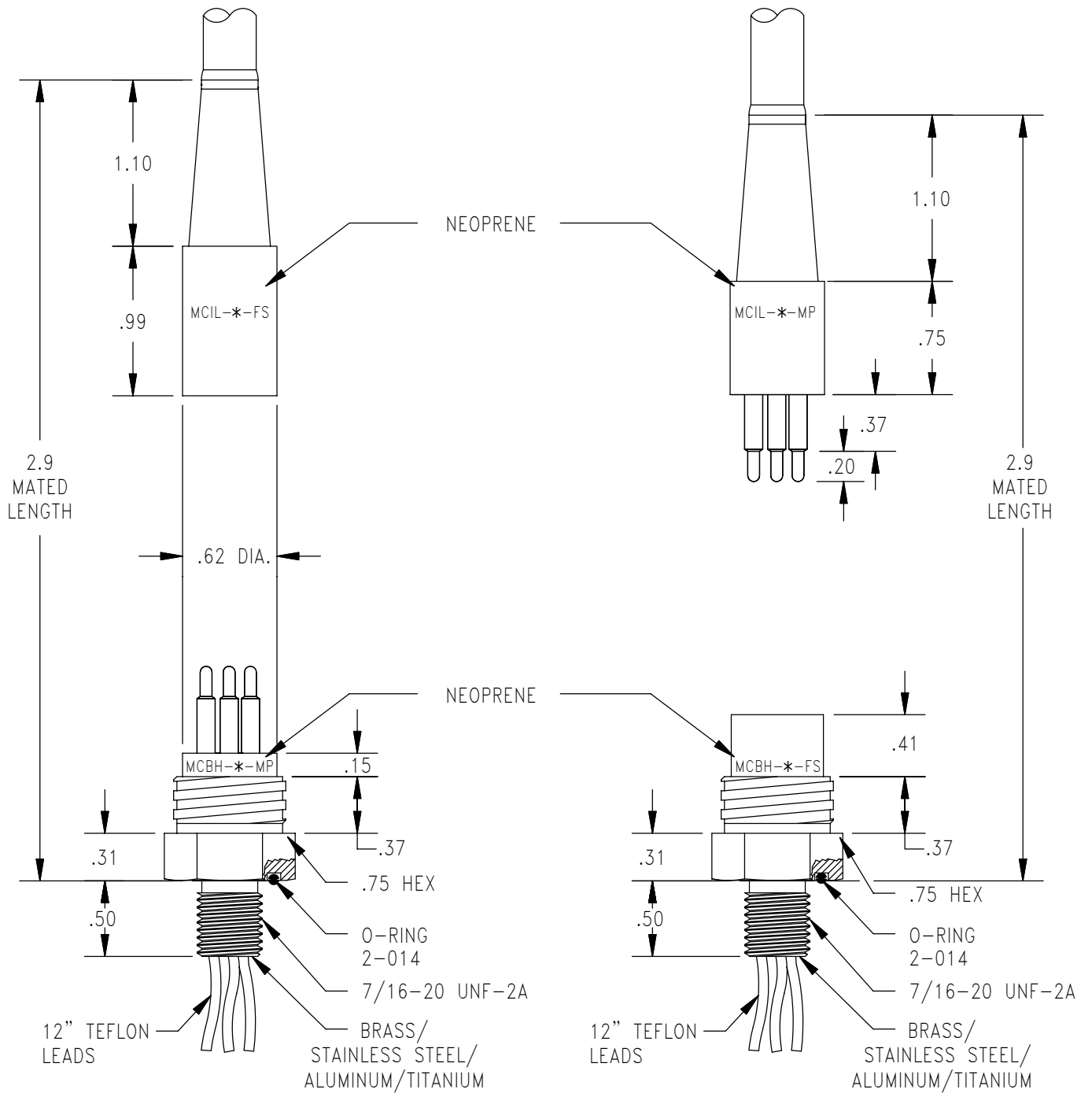

MALE

FEMALE

MCDLS-M

MCDLS-F

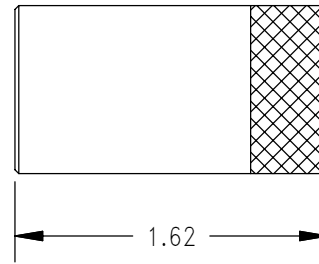
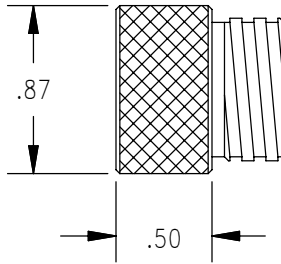

CONTACT
CONFIGURATION
(MP FACE VIEW)

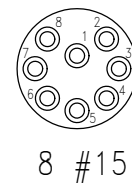
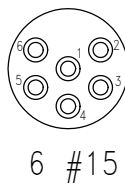
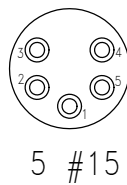

MOUNTING TORQUE FOR MCIL/BH-FS/MP	not to exceed 100 in lbs
MATED PRESSURE RATING (psi)	10,000
DUMMY PLUG FOR MCIL/BH-FS	MCDC- * -MP
DUMMY PLUG FOR MCIL/BH-MP	MCDC- * -FS
* Specify number of contacts. * Dummy plugs found on page 65 125.	
NOTE: Bulkhead body available in Titanium. Standard 3/4" thread length.	

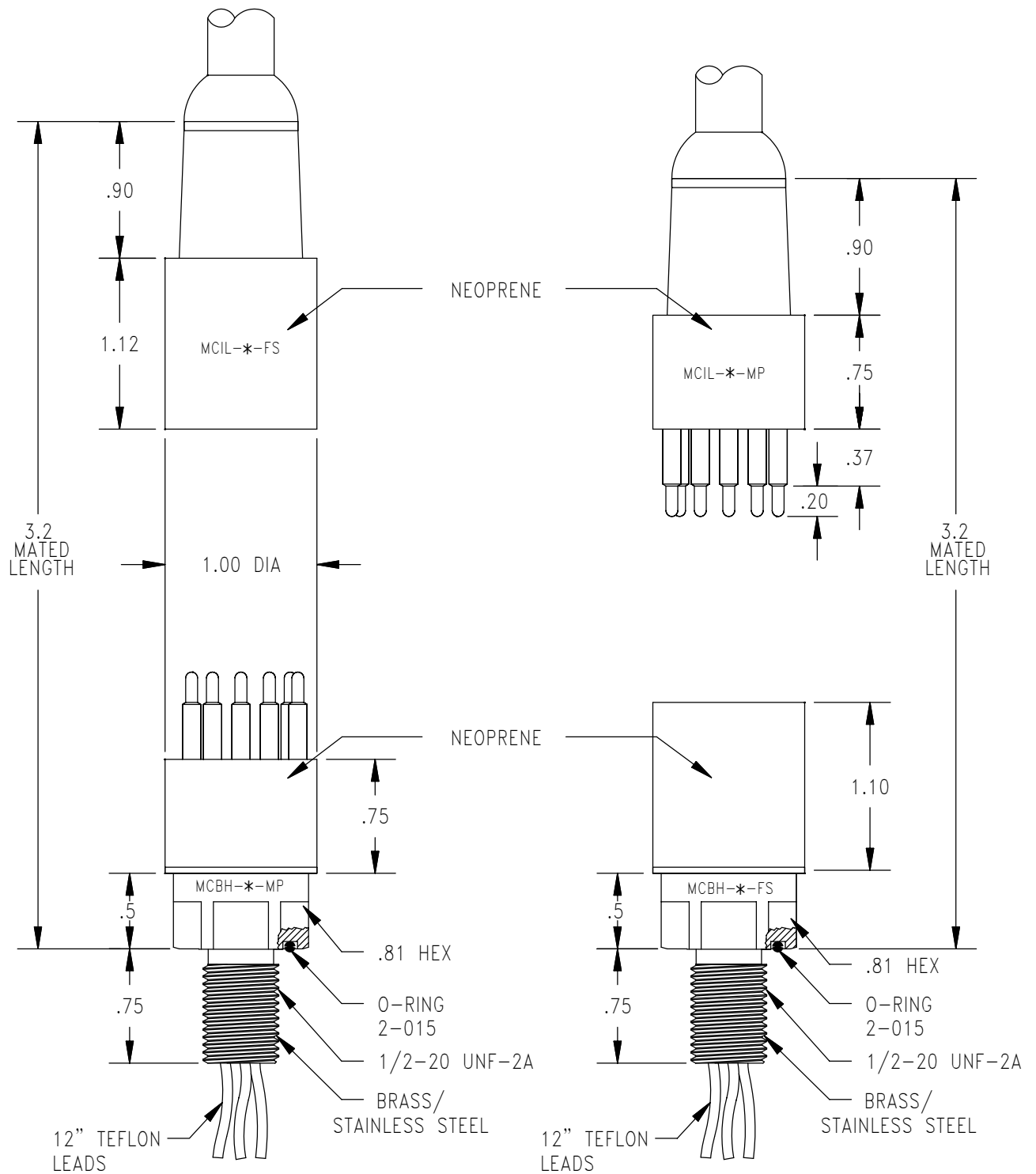

MALE

FEMALE

DLSA-M

DLSA-F

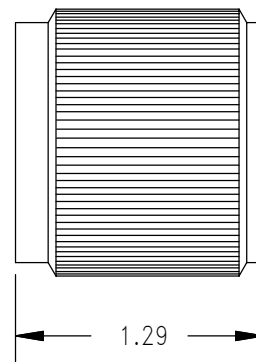
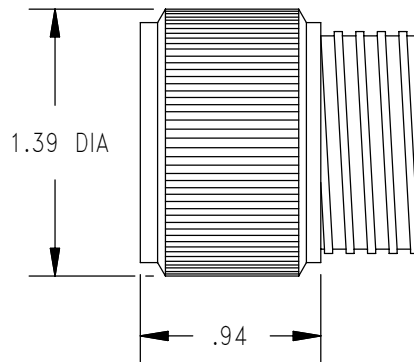

CONTACT
CONFIGURATION
(MP FACE VIEW)

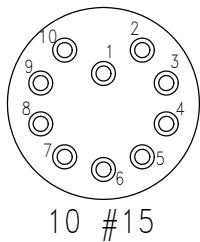

10 #15

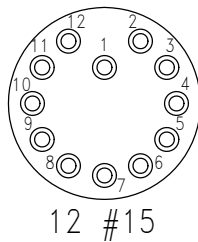

12 #15

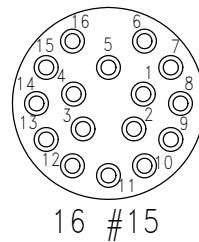

16 #15

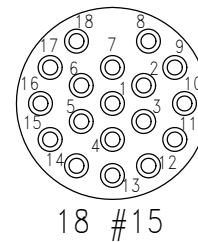

18 #15

MOUNTING TORQUE FOR MCIL/BH-FS/MP	not to exceed 100 in lbs
MATED PRESSURE RATING (psi)	10,000
DUMMY PLUG FOR MCIL/BH-FS	MCDC- * -MP
DUMMY PLUG FOR MCIL/BH-MP	MCDC- * -FS
* Specify number of contacts. * Dummy plugs found on page 65 126	
NOTE: Bulkhead body available in Titanium. Standard 3/4" thread length.	

MCLPBH/MCLPIL-9

MICRO MINI WET
PLUGGABLE

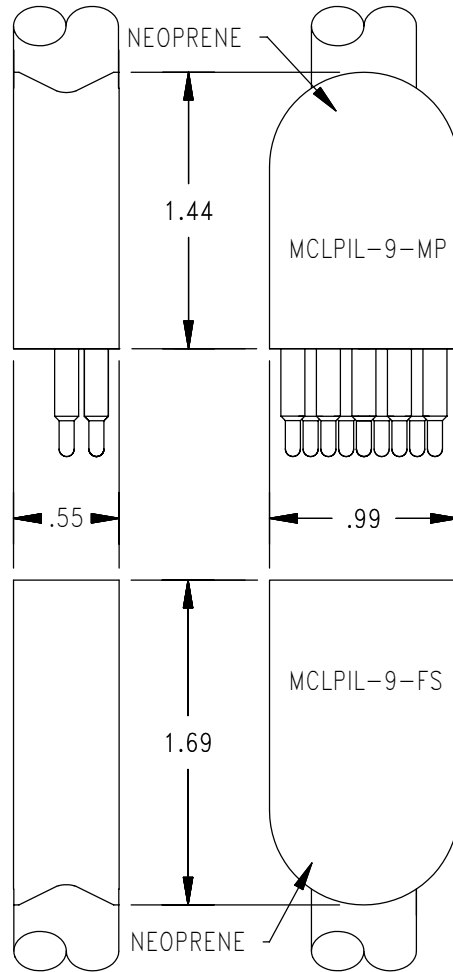
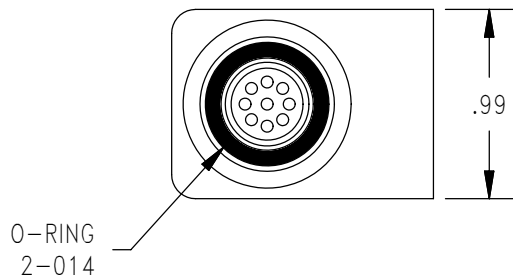
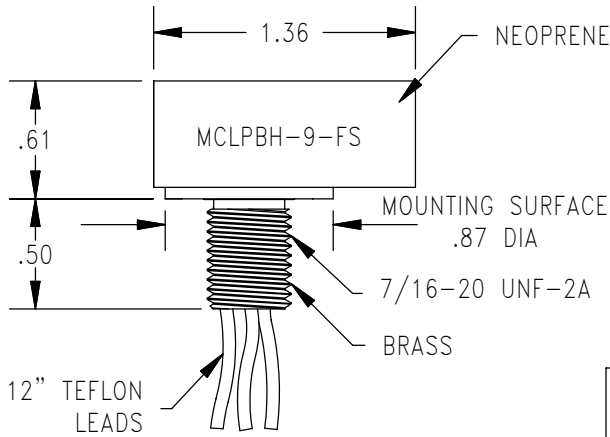
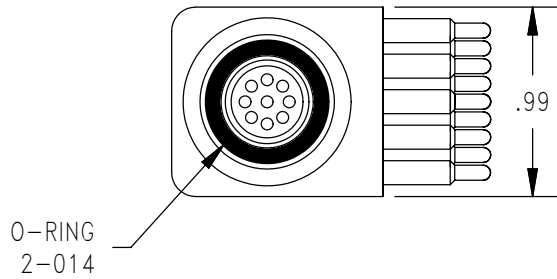
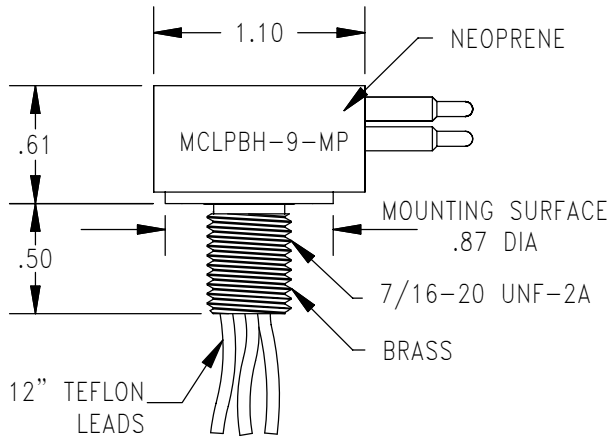

CONTACT CONFIGURATION (MP FACE VIEW)

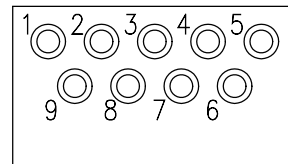

MOUNTING TORQUE FOR MCLPIL/BH-FS/MP	not to exceed 100 in/lbs
MATED PRESSURE RATING (psi)	10,000
DUMMY PLUG FOR MCLPIL/BH-FS	MCLPDC- * -MP
DUMMY PLUG FOR MCLPIL/BH-MP	MCLPDC- * -FS
NOTE: Bulkhead body available in Stainless Steel. Standard 1/2" thread length. Dummy plugs found on page 65 127	

MCDC-2/3/4/5/6/8

MICRO MINI WET
PLUGGABLE

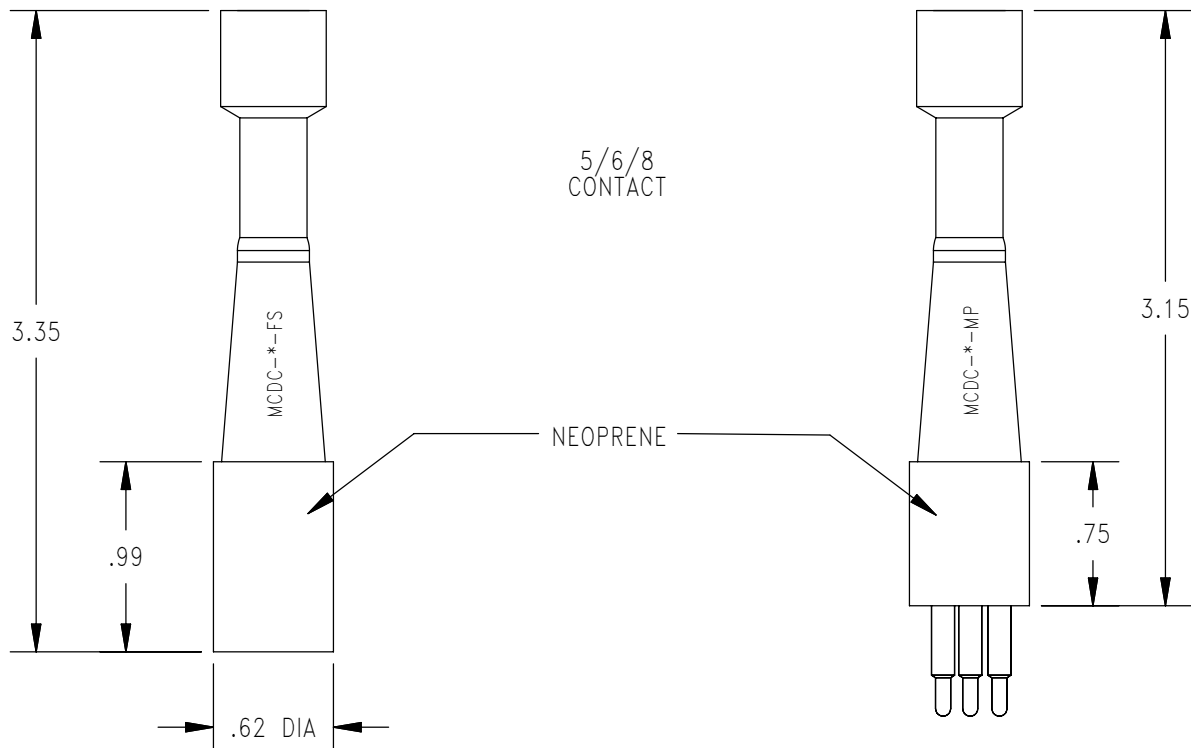
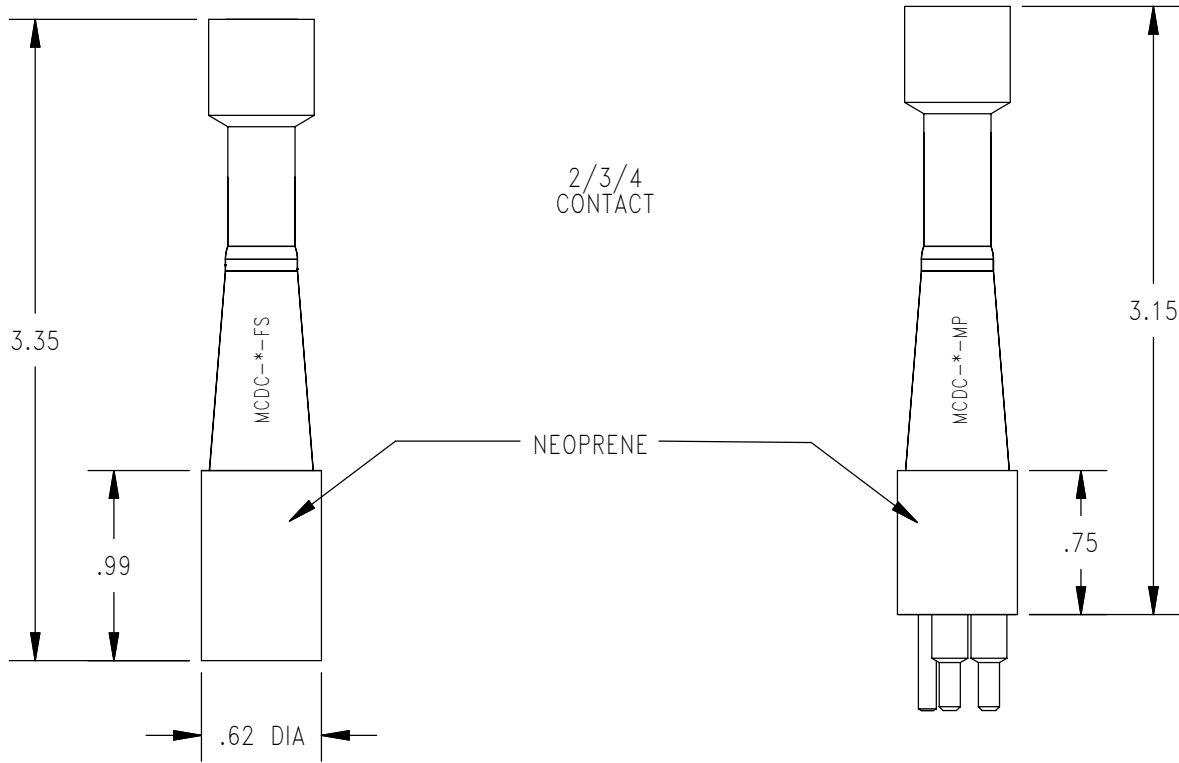

* Specify number of contacts

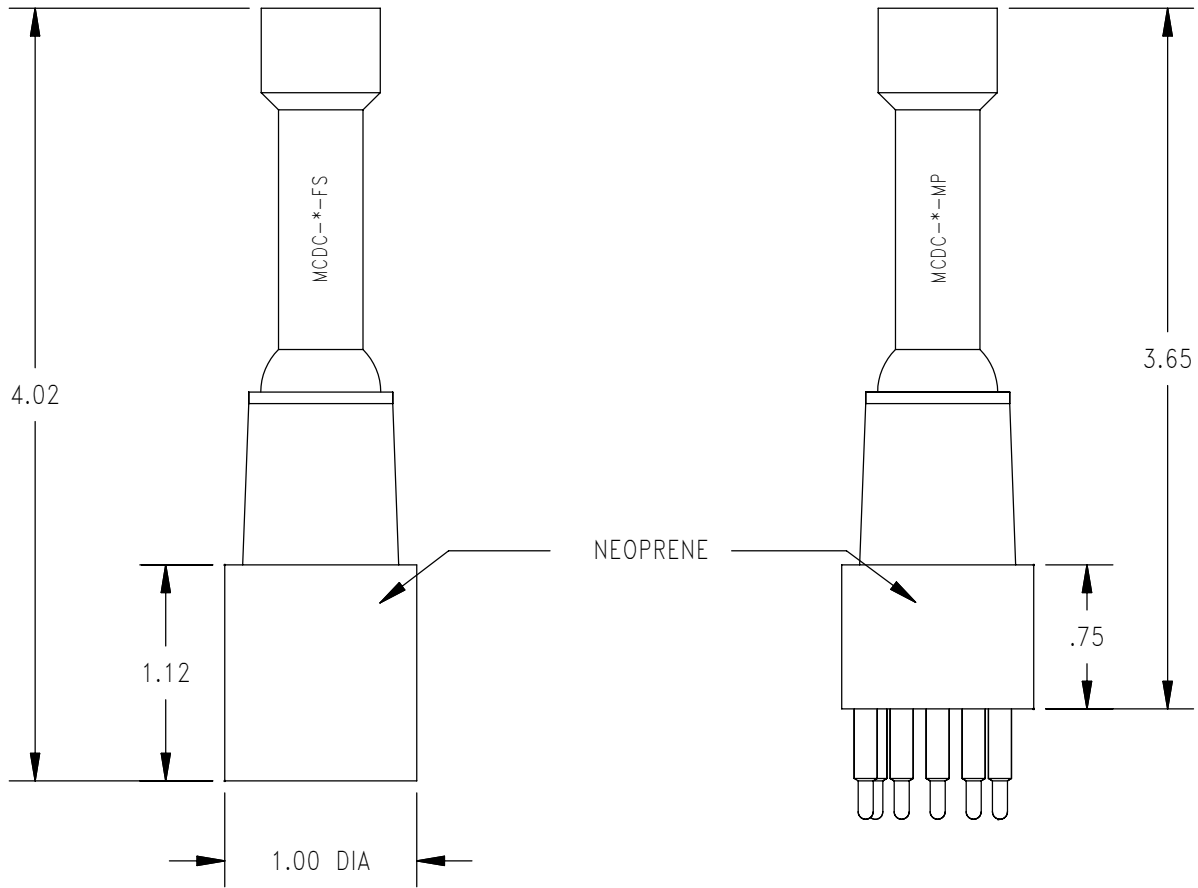

* Specify number of contacts

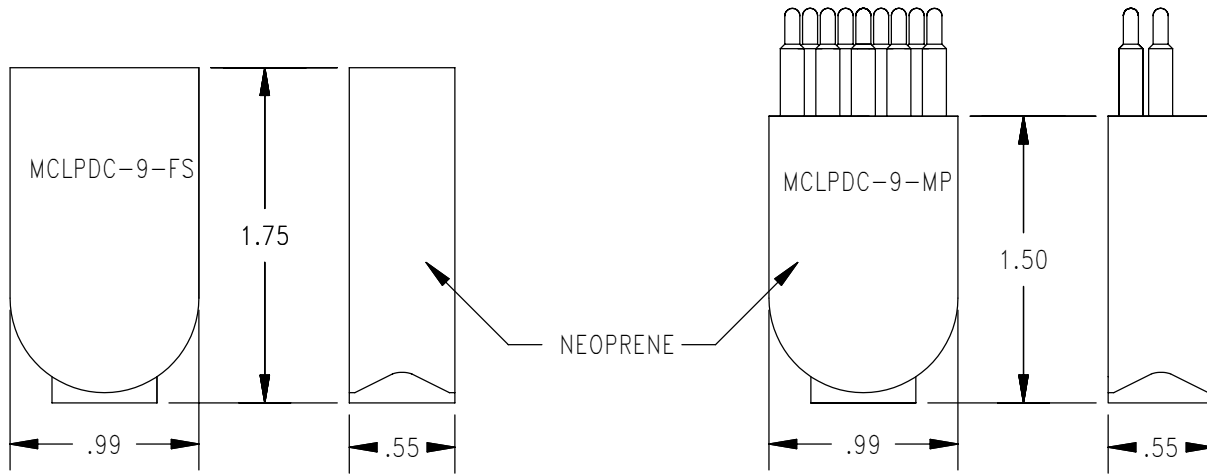

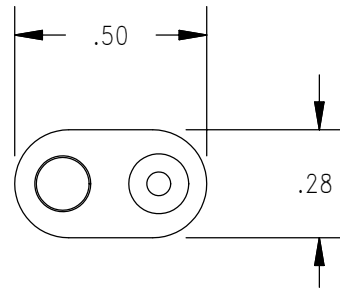
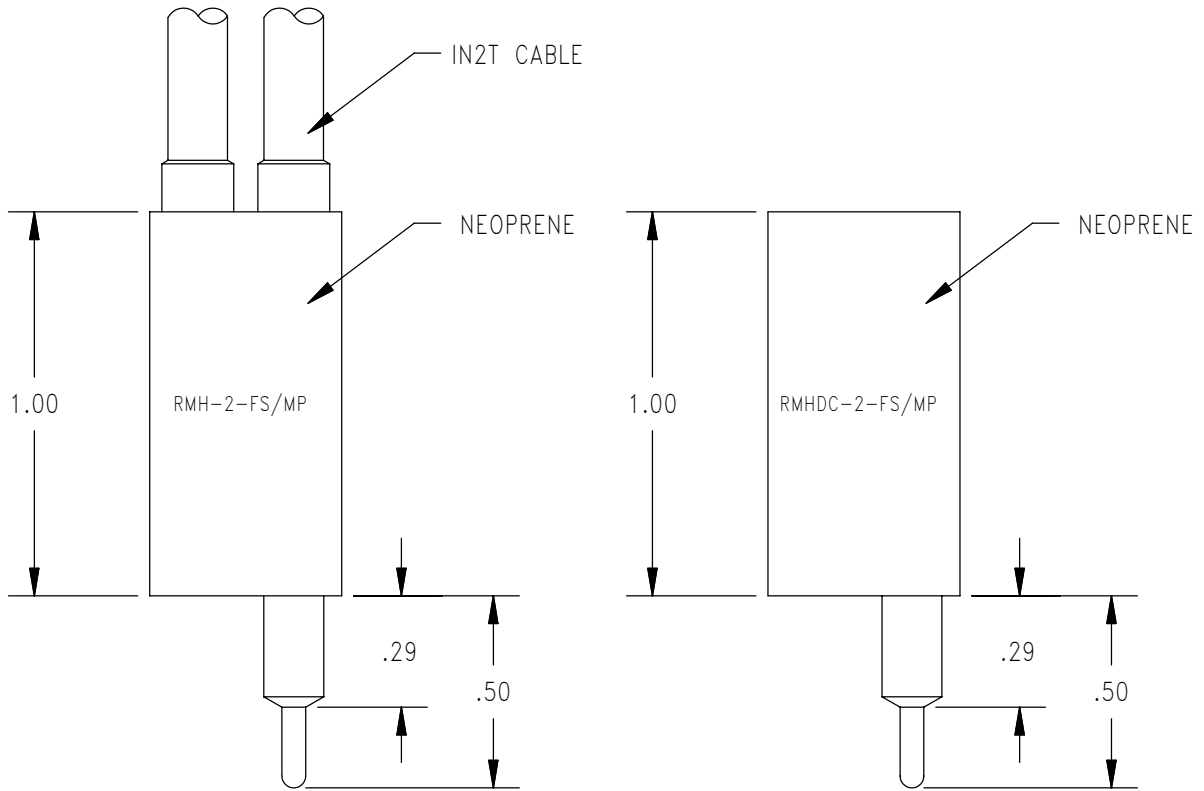

MATED PRESSURE RATING (psi)	10,000
DUMMY PLUG FOR RMH-2-FS/MP	RMHDC-2-FS/MP